

The RF Line

NPN Silicon

RF Power Transistor

... designed primarily for applications as a high-power linear amplifier from 2.0 to 30 MHz, in single sideband mobile, marine and base station equipment.

- Specified 28 Volt, 30 MHz Characteristics —
 - Output Power = 80 W (PEP)
 - Minimum Gain = 15 dB
 - Efficiency = 40%
 - Intermodulation Distortion = -32 dB (Max)

MATCHING PROCEDURE

In the push-pull circuit configuration it is preferred that the transistors are used as matched pairs to obtain optimum performance.

The matching procedure used by Motorola consists of measuring h_{FE} at the data sheet conditions and color coding the device to predetermined h_{FE} ranges within the normal h_{FE} limits. A color dot is added to the marking on top of the cap. Any two devices with the same color dot can be paired together to form a matched set of units.

MAXIMUM RATINGS

Rating	Symbol	Value	Unit
Collector-Emitter Voltage	V_{CEO}	35	Vdc
Collector-Base Voltage	V_{CBO}	65	Vdc
Emitter-Base Voltage	V_{EBO}	4.0	Vdc
Collector Current — Continuous	I_C	10	Adc
Total Device Dissipation @ $T_C = 25^\circ\text{C}$ Derate above 25°C	P_D	250 1.4	Watts W/ $^\circ\text{C}$
Storage Temperature Range	T_{stg}	-65 to +150	$^\circ\text{C}$

THERMAL CHARACTERISTICS

Characteristic	Symbol	Max	Unit
Thermal Resistance, Junction to Case	$R_{\theta JC}$	0.7	$^\circ\text{C/W}$
Stud Torque (1)	—	8.5	In. Lb.

ELECTRICAL CHARACTERISTICS ($T_C = 25^\circ\text{C}$ unless otherwise noted.)

Characteristic	Symbol	Min	Max	Unit
----------------	--------	-----	-----	------

OFF CHARACTERISTICS

Collector-Emitter Breakdown Voltage ($I_C = 100 \text{ mAdc}$, $I_B = 0$)	$V_{(BR)CEO}$	35	—	Vdc
Collector-Emitter Breakdown Voltage ($I_C = 100 \text{ mAdc}$, $V_{BE} = 0$)	$V_{(BR)CES}$	65	—	Vdc
Emitter-Base Breakdown Voltage ($I_E = 1.0 \text{ mAdc}$, $I_C = 0$)	$V_{(BR)EBO}$	4.0	—	Vdc
Collector Cutoff Current ($V_{CE} = 28 \text{ Vdc}$, $V_{BE} = 0$, $T_C = +55^\circ\text{C}$)	I_{CES}	—	10	mAdc

ON CHARACTERISTICS

DC Current Gain ($I_C = 0.5 \text{ Adc}$, $V_{CE} = 5.0 \text{ Vdc}$)	h_{FE}	10	—	—
---	----------	----	---	---

NOTE:

- Case 145A-10 — For Repeated Assembly Use 11 In. Lb.

(continued)

MRF464

**80 W (PEP), 30 MHz
RF POWER
TRANSISTOR
NPN SILICON**

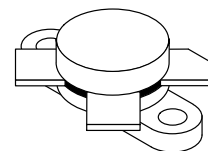

CASE 211-11, STYLE 1

ELECTRICAL CHARACTERISTICS — continued ($T_C = 25^\circ\text{C}$ unless otherwise noted.)

Characteristic	Symbol	Min	Max	Unit
DYNAMIC CHARACTERISTICS				
Output Capacitance ($V_{CB} = 28\text{ Vdc}$, $I_E = 0$, $f = 1.0\text{ MHz}$)	C_{ob}	—	200	pF
FUNCTIONAL TESTS				
Common-Emitter Amplifier Power Gain (Figure 1) ($P_{out} = 80\text{ W (PEP)}$, $I_C = 3.6\text{ Adc (Max)}$, $V_{CC} = 28\text{ Vdc}$, $f_1 = 30\text{ MHz}$, $f_2 = 30.001\text{ MHz}$)	G_{PE}	15	—	dB
Intermodulation Distortion Ratio (Figure 1) (2) ($P_{out} = 80\text{ W (PEP)}$, $I_C = 3.6\text{ Adc (Max)}$, $V_{CC} = 28\text{ Vdc}$, $f_1 = 30\text{ MHz}$, $f_2 = 30.001\text{ MHz}$)	IMD	—	-32	dB
Collector Efficiency ($P_{out} = 80\text{ W (PEP)}$, $I_C = 3.6\text{ Adc (Max)}$, $V_{CC} = 28\text{ Vdc}$, $f_1 = 30\text{ MHz}$, $f_2 = 30.001\text{ MHz}$)	η	40	—	%

NOTE:

2. To Mil-Std-1311 Version A, Test Method 2204B, Two Tone, Reference each Tone.

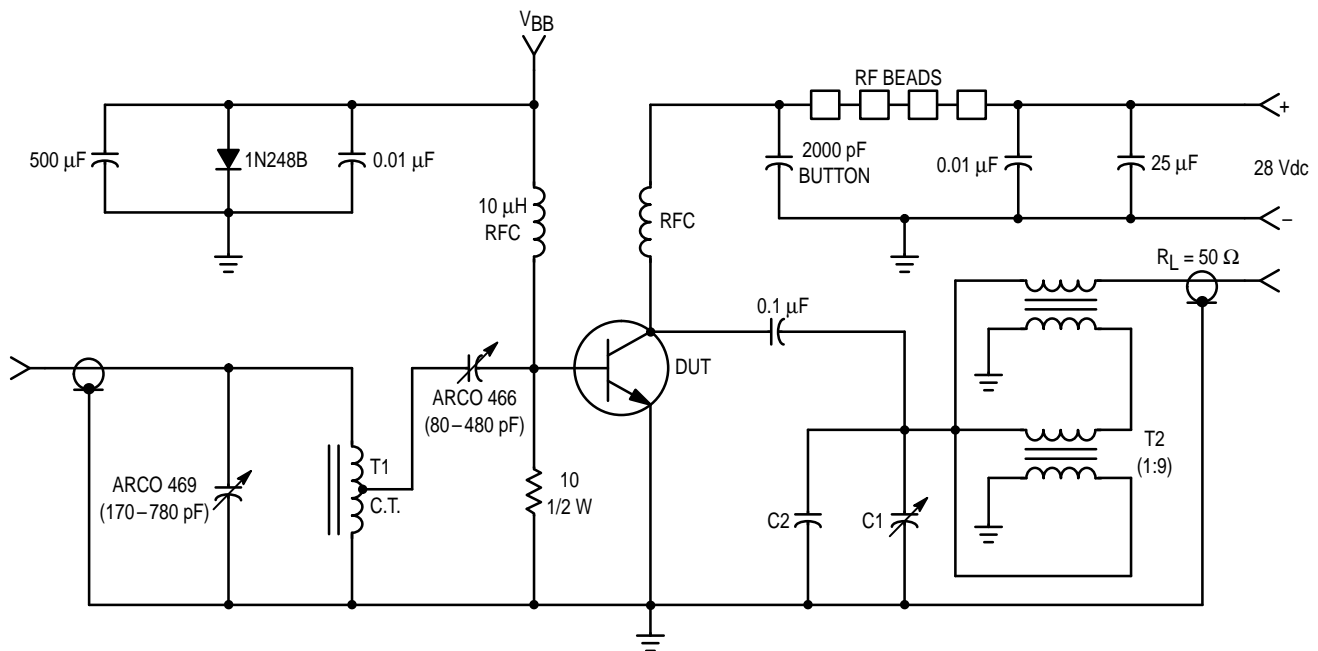

RFC — 20 Turns @ 12 AWG Enameled Wire Close Wound in 2 Layers, 1/4" I.D.

T1 — 20 Turns #24 AWG Wire Wound on Micro-Metals T37-7 Toroid Core Center Tapped.

T2 — 1:9 XFMR; 6 Turns of 2 Twisted Pairs of #28 AWG Enameled Wire. (8 Crests Per Inch) Bifilar Wound on Each of 2 Separate Balun Cores. (Stackpole #57-1503, No. 14 Material) Interconnected as shown

RF Beads — Ferroxcube #56-590-65/3B

V_{BB} adjusted for I_{CQ} — 40 mA dc (I_{CQ} = Quiescent Collector Current)

C1 — 170-180 pF ARCO 469 or Equivalent

C2 — 330 pF

Figure 1. 30 MHz Test Circuit

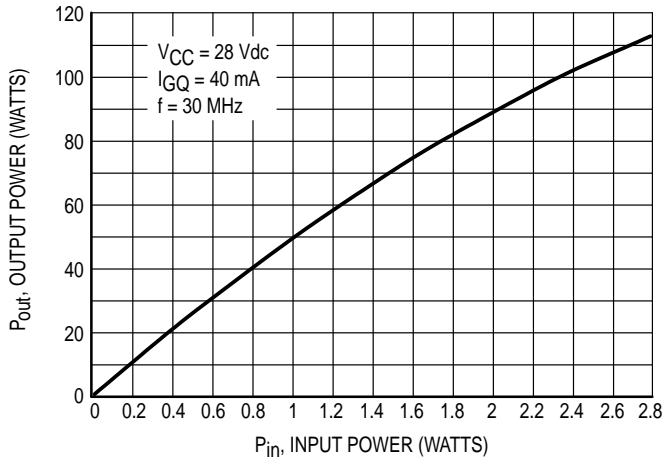

Figure 2. Output Power versus Input Power

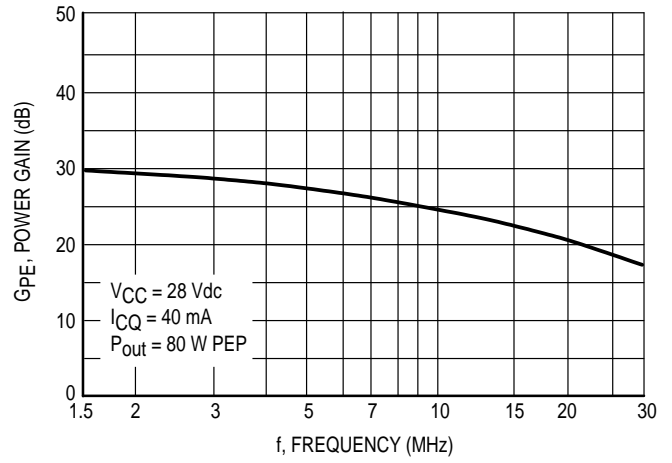

Figure 3. Power Gain versus Frequency

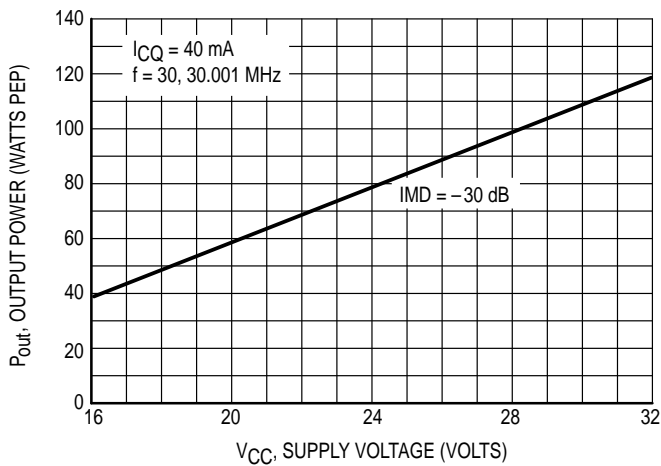

Figure 4. Output Power versus Supply Voltage

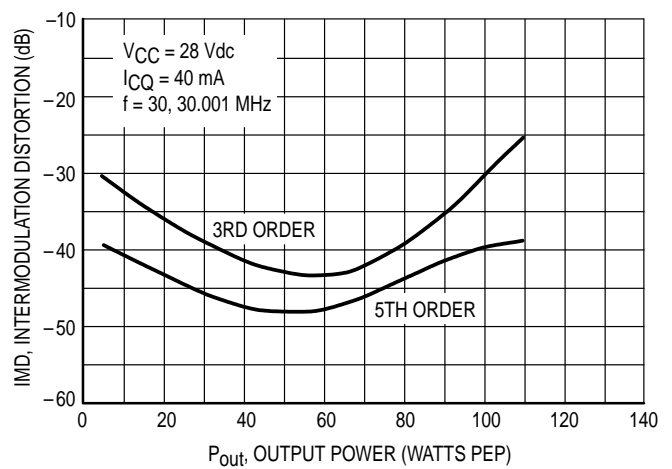

Figure 5. Intermodulation Distortion versus Output Power

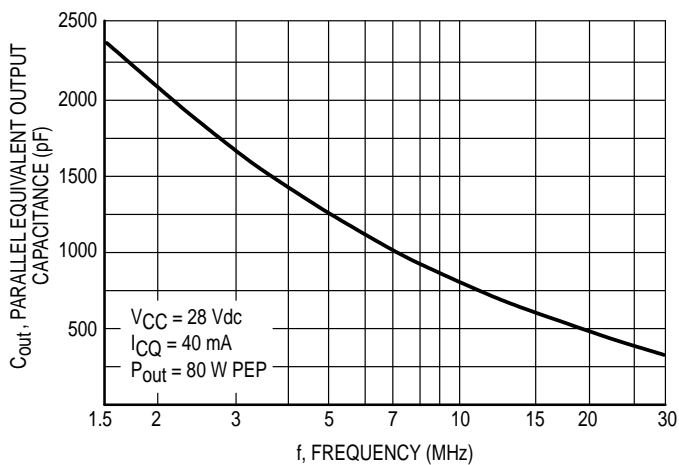

Figure 6. Output Capacitance versus Frequency

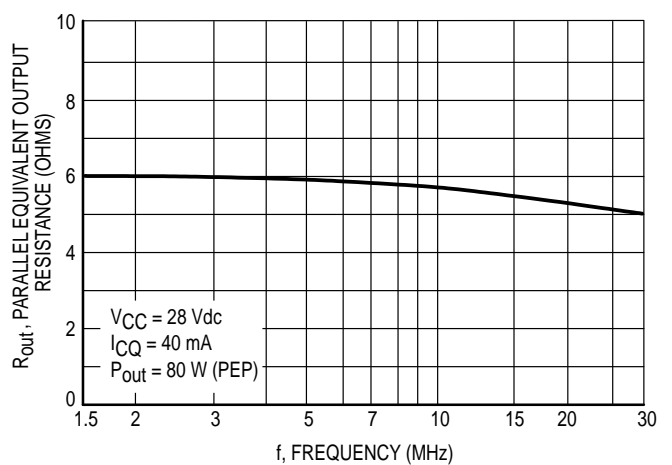

Figure 7. Output Resistance versus Frequency

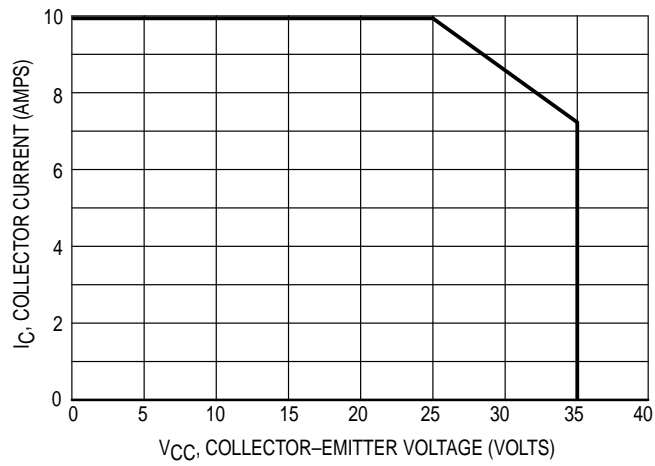

Figure 8. DC Safe Operating Area

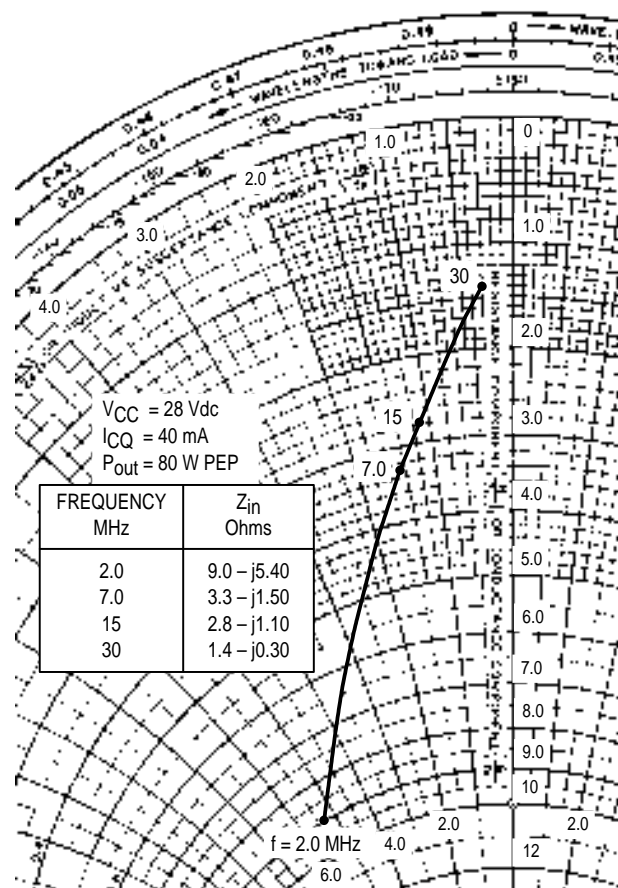
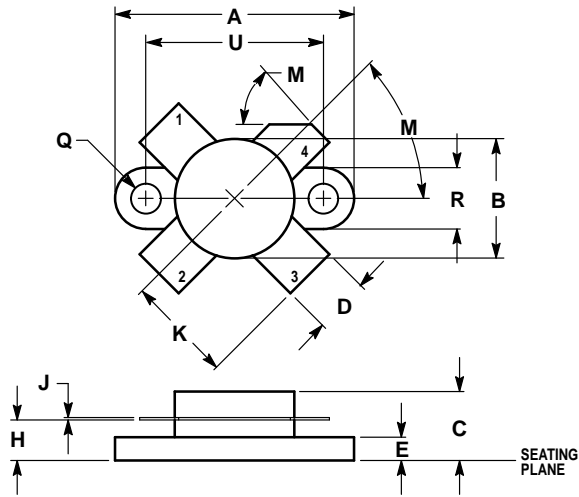

Figure 9. Series Input Impedance

PACKAGE DIMENSIONS



- NOTES:
 1. DIMENSIONING AND TOLERANCING PER ANSI Y14.5M, 1982.
 2. CONTROLLING DIMENSION: INCH.

DIM	INCHES		MILLIMETERS	
	MIN	MAX	MIN	MAX
A	0.960	0.990	24.39	25.14
B	0.465	0.510	11.82	12.95
C	0.229	0.275	5.82	6.98
D	0.216	0.235	5.49	5.96
E	0.084	0.110	2.14	2.79
H	0.144	0.178	3.66	4.52
J	0.003	0.007	0.08	0.17
K	0.435	—	11.05	—
M	45°NOM		45°NOM	
Q	0.115	0.130	2.93	3.30
R	0.246	0.255	6.25	6.47
U	0.720	0.730	18.29	18.54

- STYLE 1:
 PIN 1. EMITTER
 2. BASE
 3. EMITTER
 4. COLLECTOR

**CASE 211-11
 ISSUE N**

Motorola reserves the right to make changes without further notice to any products herein. Motorola makes no warranty, representation or guarantee regarding the suitability of its products for any particular purpose, nor does Motorola assume any liability arising out of the application or use of any product or circuit, and specifically disclaims any and all liability, including without limitation consequential or incidental damages. "Typical" parameters can and do vary in different applications. All operating parameters, including "Typicals" must be validated for each customer application by customer's technical experts. Motorola does not convey any license under its patent rights nor the rights of others. Motorola products are not designed, intended, or authorized for use as components in systems intended for surgical implant into the body, or other applications intended to support or sustain life, or for any other application in which the failure of the Motorola product could create a situation where personal injury or death may occur. Should Buyer purchase or use Motorola products for any such unintended or unauthorized application, Buyer shall indemnify and hold Motorola and its officers, employees, subsidiaries, affiliates, and distributors harmless against all claims, costs, damages, and expenses, and reasonable attorney fees arising out of, directly or indirectly, any claim of personal injury or death associated with such unintended or unauthorized use, even if such claim alleges that Motorola was negligent regarding the design or manufacture of the part. Motorola and  are registered trademarks of Motorola, Inc. Motorola, Inc. is an Equal Opportunity/Affirmative Action Employer.

Literature Distribution Centers:

USA: Motorola Literature Distribution; P.O. Box 20912; Phoenix, Arizona 85036.

EUROPE: Motorola Ltd.; European Literature Centre; 88 Tanners Drive, Blakelands, Milton Keynes, MK14 5BP, England.

JAPAN: Nippon Motorola Ltd.; 4-32-1, Nishi-Gotanda, Shinagawa-ku, Tokyo 141, Japan.

ASIA PACIFIC: Motorola Semiconductors H.K. Ltd.; Silicon Harbour Center, No. 2 Dai King Street, Tai Po Industrial Estate, Tai Po, N.T., Hong Kong.



MRF464/D

