

The RF Sub-Micron Bipolar Line RF Power Bipolar Transistors

The MRF20060 and MRF20060S are designed for broadband commercial and industrial applications at frequencies from 1800 to 2000 MHz. The high gain, excellent linearity and broadband performance of these devices make them ideal for large-signal, common emitter class A and class AB amplifier applications. These devices are suitable for frequency modulated, amplitude modulated and multi-carrier base station RF power amplifiers.

- Guaranteed Two-tone Performance at 2000 MHz, 26 Volts
Output Power — 60 Watts (PEP)
Power Gain — 9 dB
Efficiency — 33%
Intermodulation Distortion — -30 dBc
- Characterized with Series Equivalent Large-Signal Impedance Parameters
- S-Parameter Characterization at High Bias Levels
- Excellent Thermal Stability
- Capable of Handling 3:1 VSWR @ 26 Vdc, 2000 MHz, 60 Watts (PEP) Output Power
- Designed for FM, TDMA, CDMA and Multi-Carrier Applications

MRF20060
MRF20060S

60 W, 2000 MHz
RF POWER
BROADBAND
NPN BIPOLAR

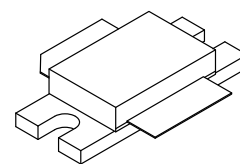

CASE 451-04, STYLE 1
(MRF20060)

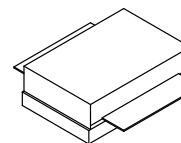

CASE 451A-01, STYLE 1
(MRF20060S)

MAXIMUM RATINGS

Rating	Symbol	Value	Unit
Collector-Emitter Voltage ($I_B = 0$ mA)	V_{CEO}	25	Vdc
Collector-Emitter Voltage	V_{CES}	60	Vdc
Collector-Base Voltage	V_{CBO}	60	Vdc
Collector-Emitter Voltage ($R_{BE} = 100$ Ohm)	V_{CER}	30	Vdc
Base-Emitter Voltage	V_{EB}	- 3	Vdc
Collector Current - Continuous	I_C	8	Adc
Total Device Dissipation @ $T_C = 25^\circ\text{C}$ Derate above 25°C	P_D	250 1.43	Watts W/ $^\circ\text{C}$
Storage Temperature Range	T_{stg}	- 65 to +150	$^\circ\text{C}$
Operating Junction Temperature	T_J	200	$^\circ\text{C}$

THERMAL CHARACTERISTICS

Rating	Symbol	Max	Unit
Thermal Resistance, Junction to Case	$R_{\theta JC}$	0.7	$^\circ\text{C}/\text{W}$

ELECTRICAL CHARACTERISTICS ($T_C = 25^\circ\text{C}$ unless otherwise noted)

Characteristic	Symbol	Min	Typ	Max	Unit
----------------	--------	-----	-----	-----	------

OFF CHARACTERISTICS

Collector–Emitter Breakdown Voltage ($I_C = 50\text{ mAdc}$, $I_B = 0$)	$V_{(BR)CEO}$	25	26	—	Vdc
Collector–Emitter Breakdown Voltage ($I_C = 50\text{ mAdc}$, $V_{BE} = 0$)	$V_{(BR)CES}$	60	69	—	Vdc
Collector–Base Breakdown Voltage ($I_C = 50\text{ mAdc}$, $I_E = 0$)	$V_{(BR)CBO}$	60	69	—	Vdc
Reverse Base–Emitter Breakdown Voltage ($I_B = 10\text{ mAdc}$, $I_C = 0$)	$V_{(BR)EBO}$	3	3.5	—	Vdc
Zero Base Voltage Collector Leakage Current ($V_{CE} = 30\text{ Vdc}$, $V_{BE} = 0$)	I_{CES}	—	—	10	mAdc

ON CHARACTERISTICS

DC Current Gain ($V_{CE} = 5\text{ Vdc}$, $I_C = 1\text{ Adc}$)	h_{FE}	20	40	80	—
---	----------	----	----	----	---

DYNAMIC CHARACTERISTICS

Output Capacitance ($V_{CB} = 26\text{ Vdc}$, $I_E = 0$, $f = 1.0\text{ MHz}$) (1)	C_{ob}	—	55	—	pF
---	----------	---	----	---	----

FUNCTIONAL TESTS (In Motorola Test Fixture)

Common–Emitter Amplifier Power Gain ($V_{CC} = 26\text{ Vdc}$, $P_{out} = 60\text{ Watts (PEP)}$, $I_{CQ} = 200\text{ mA}$, $f_1 = 2000.0\text{ MHz}$, $f_2 = 2000.1\text{ MHz}$)	G_{pe}	9	9.4	—	dB
Collector Efficiency ($V_{CC} = 26\text{ Vdc}$, $P_{out} = 60\text{ Watts (PEP)}$, $I_{CQ} = 200\text{ mA}$, $f_1 = 2000.0\text{ MHz}$, $f_2 = 2000.1\text{ MHz}$)	η	33	35	—	%
Intermodulation Distortion ($V_{CC} = 26\text{ Vdc}$, $P_{out} = 60\text{ Watts (PEP)}$, $I_{CQ} = 200\text{ mA}$, $f_1 = 2000.0\text{ MHz}$, $f_2 = 2000.1\text{ MHz}$)	IMD	—	– 33	– 30	dB
Input Return Loss ($V_{CC} = 26\text{ Vdc}$, $P_{out} = 60\text{ Watts (PEP)}$, $I_{CQ} = 200\text{ mA}$, $f_1 = 2000.0\text{ MHz}$, $f_2 = 2000.1\text{ MHz}$)	IRL	12	19	—	dB
Output Mismatch Stress ($V_{CC} = 26\text{ Vdc}$, $P_{out} = 60\text{ Watts (PEP)}$, $I_{CQ} = 200\text{ mA}$, $f_1 = 2000.0\text{ MHz}$, $f_2 = 2000.1\text{ MHz}$, $V_{SWR} = 3:1$, All Phase Angles at Frequency of Test)	ψ	No Degradation in Output Power			

(1) For Information Only. This Part Is Collector Matched.

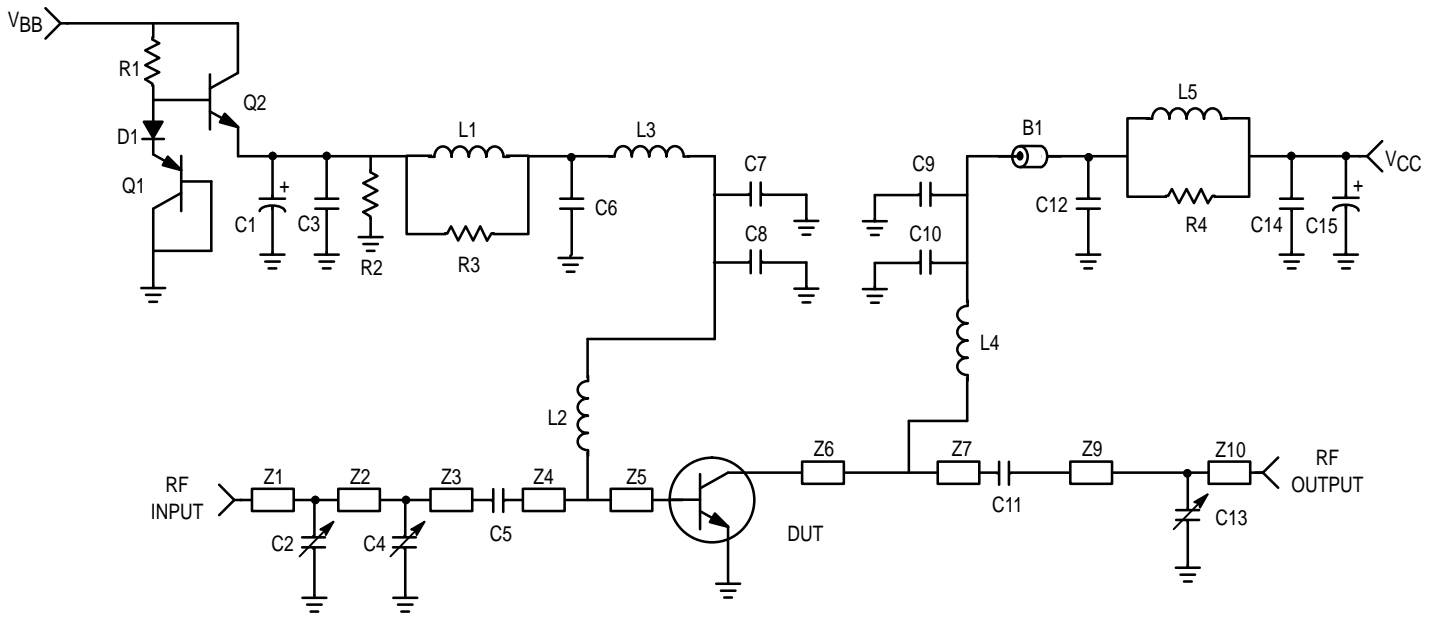

B1	Ferrite Bead, P/N 5659065/3B, Ferroxcube	D1	Diode, Motorola (MUR3160T3)
C1	100 μ F, 50 V, Electrolytic Capacitor, Mallory	L1, L5	12 Turns, 22 AWG, 0.140" Choke
C2, C4, C13	0.6–4.0 pF, Variable Capacitor, Gigatrim, Johanson	L2, L4	.5 inch of 20 AWG, ID Choke
C3, C14	0.1 μ F, Chip Capacitor, Kemit	L3	12.5 nH Inductor
C5	15 pF, B Case Chip Capacitor, ATC	R1	2 x 130 Ω , 1/8 W Chip Resistor, Rohm
C6, C12	1000 pF, B Case Chip Capacitor, ATC	R2	2 x 100 Ω , 1/8 W Chip Resistor, Rohm
C7, C9	91 pF, B Case Chip Capacitor, ATC	R3, R4	10 Ω , 1/2 W, Resistor
C8, C10	24 pF, B Case Chip Capacitor, ATC	Q1	Transistor, PNP Motorola (BD136)
C11	13 pF, B Case Chip Capacitor, ATC	Q2	Transistor, NPN Motorola (MJD47)
C15	470 μ F, 50 V, Electrolytic Capacitor, Mallory	Board	Glass Teflon [®] , Arlon GX-0300-55-22, $\epsilon_r = 2.55$

Figure 1. Class AB, 1.93 – 2 GHz Test Fixture Electrical Schematic

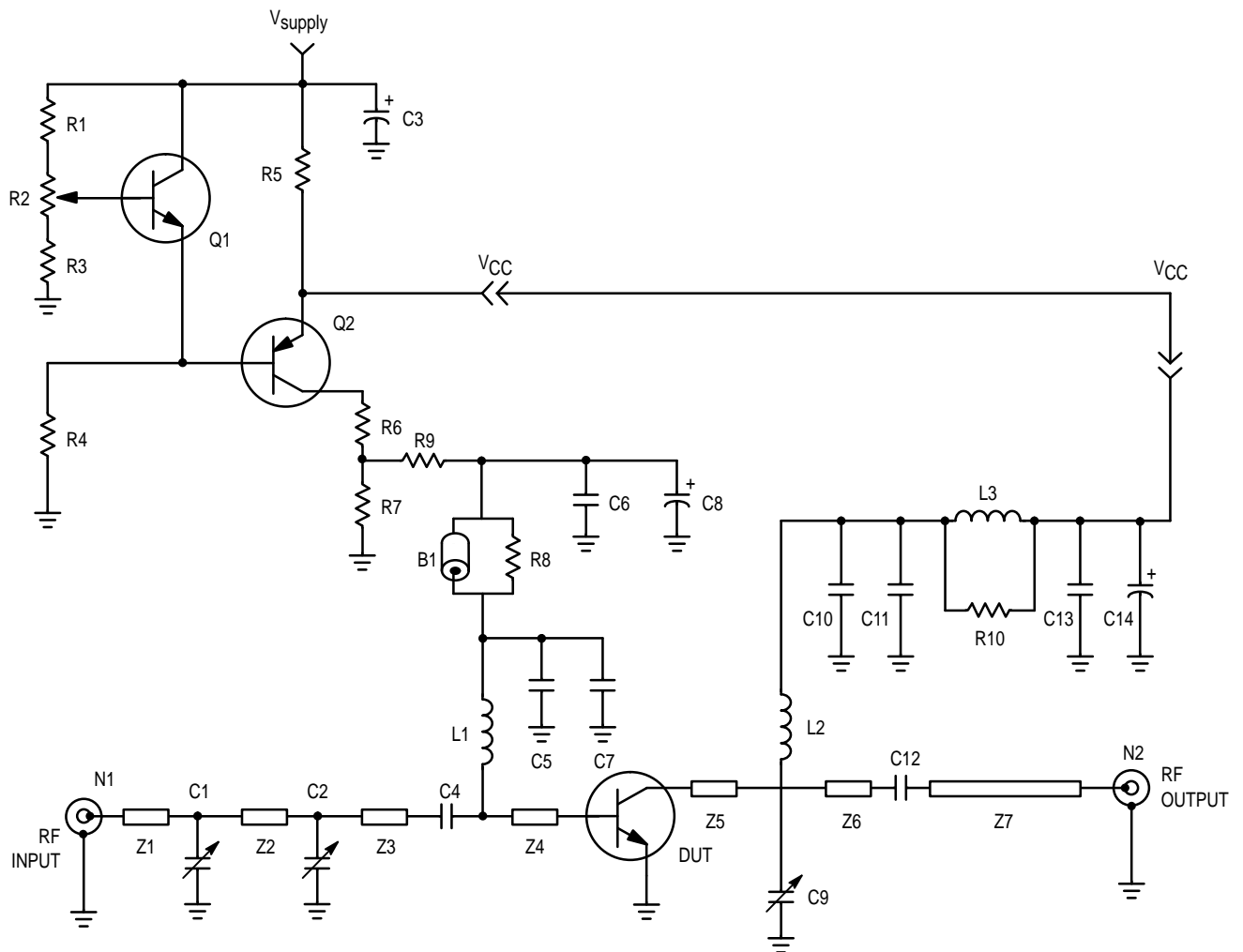

B1	Short Bead, Fair Rite	N1, N2	Type N Flange Mount RF 55–22, Connector, Omni Spectra
C1, C2	0.6–4.5 pF, Trimmer, Gigatrim, Johanson	Q1	Transistor, NPN, Motorola (BD135)
C3, C8	100 μ F, 50 V Electrolytic, Mallory	Q2	Transistor, PNP, Motorola (BD136)
C4, C12	12 pF, Chip Capacitor, ATC	R1	270 Ω , Chip Resistor, 1/8 Watt, Rohm
C5, C11	91 pF, Chip Capacitor, ATC	R2	10 K Ω , 1/4 Watt, Potentiometer
C6	0.01 μ F, Chip Capacitor, ATC	R3	4.7 K Ω , Chip Resistor, 1/8 Watt, Rohm
C7, C10	24 pF, Chip Capacitor, ATC	R4	2 x 4.7 K Ω , Chip Resistor, 1/8 Watt, Rohm
C9	0.4–2.5 pF, Trimmer, Gigatrim, Johanson	R5	1.0 Ω , 25 Watt, 1% Resistor, DALE
C13	0.1 μ F, Chip Capacitor, ATC	R6	38 Ω , Axial Lead, 1 Watt Resistor
C14	470 μ F, 63 V Electrolytic, Mallory	R7	4.2 K Ω , Chip Resistor, 1/8 Watt, Rohm
L1	2 Turn, 27 AWG, 0.049" ID Coil	R8	3 x 39 Ω , Chip Resistors, 1/8 Watt, Rohm
L2	0.041" dia., 0.7" Length Wire	R9	2 x 10 Ω , Chip Resistor, 1/8 Watt, Rohm
L3	11 Turn, 20 AWG, 0.19" ID Coil	R10	10 Ω , Axial Lead, 1 Watt Resistor
		Board	Glass Teflon [®] , Arlon GX-0300-55-22, $\epsilon_r = 2.55$

Figure 2. Class A, 1.93 – 2 GHz Test Fixture Electrical Schematic

TYPICAL CHARACTERISTICS

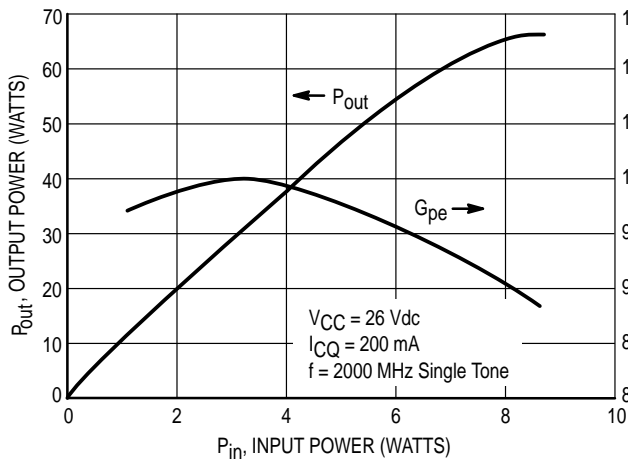

Figure 3. Output Power & Power Gain versus Input Power

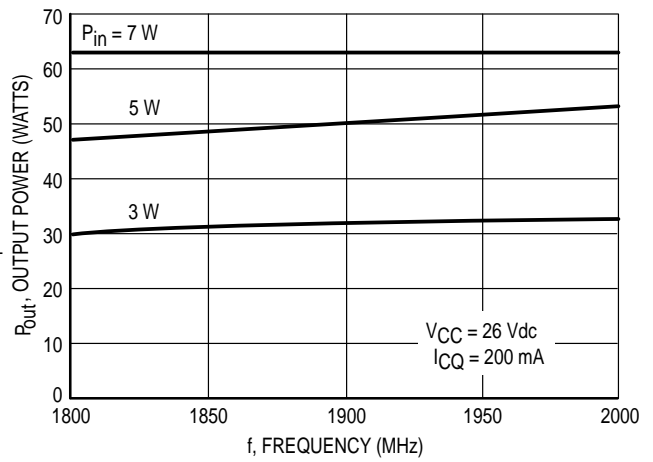

Figure 4. Output Power versus Frequency

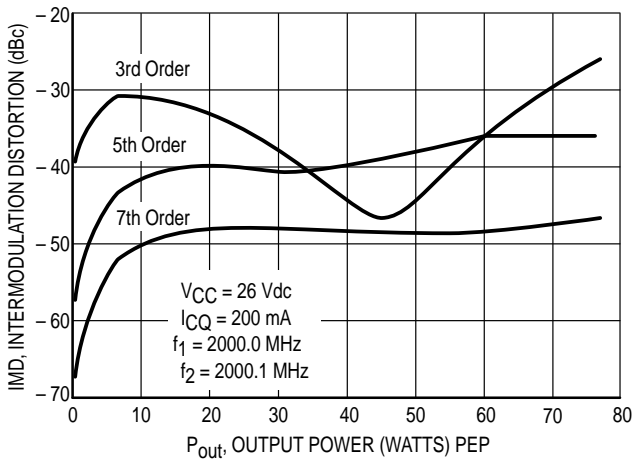

Figure 5. Intermodulation Distortion versus Output Power

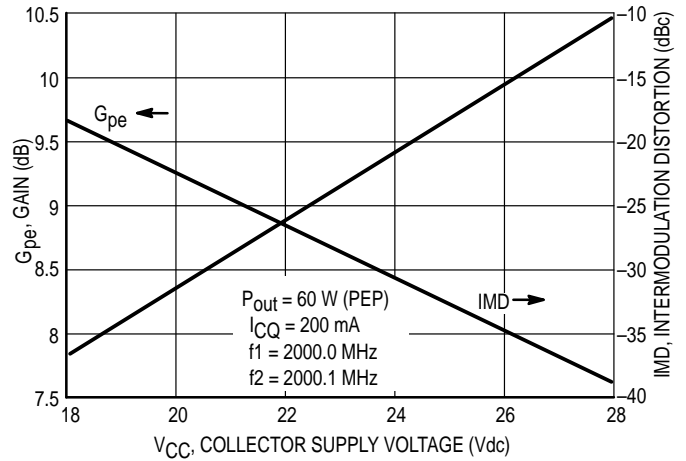

Figure 6. Power Gain and Intermodulation Distortion versus Supply Voltage

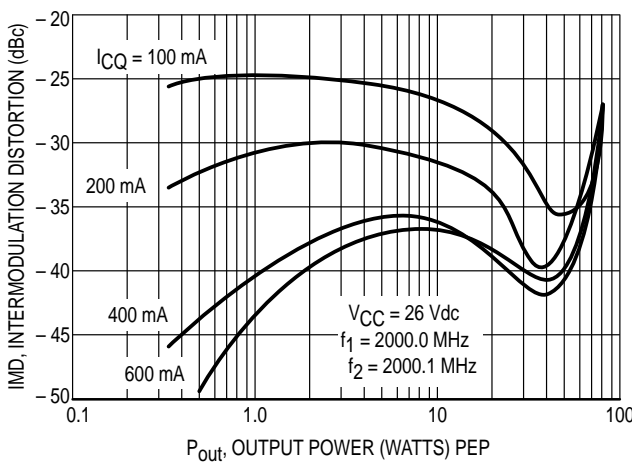

Figure 7. Intermodulation Distortion versus Output Power

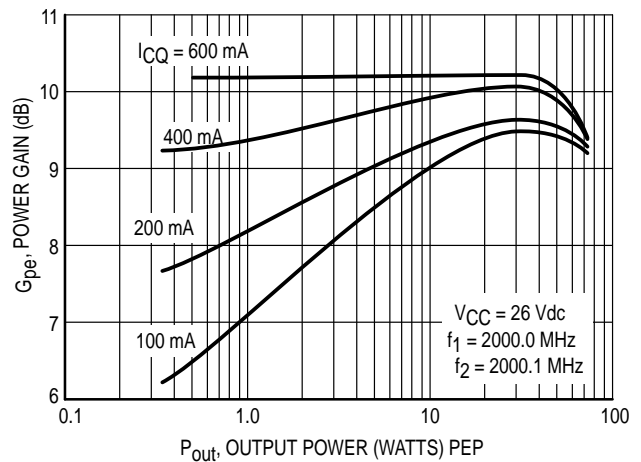

Figure 8. Power Gain versus Output Power

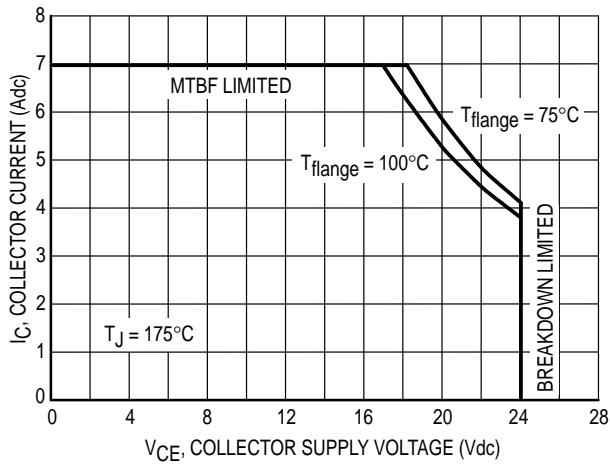

Figure 9. Class A DC Safe Operating Area

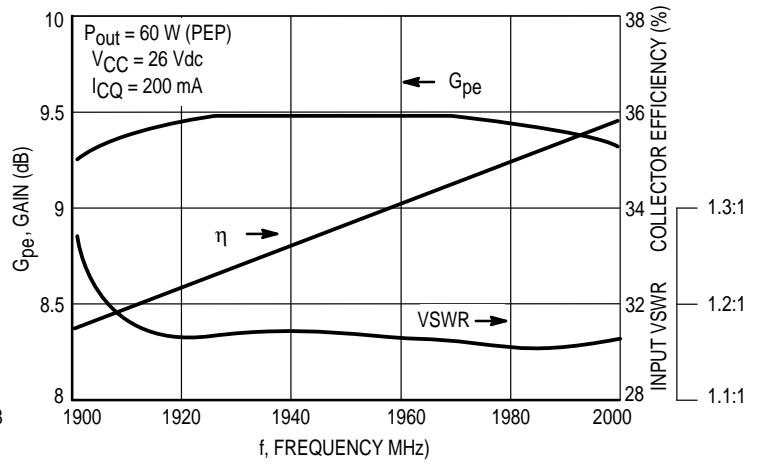

Figure 10. Performance in Broadband Circuit

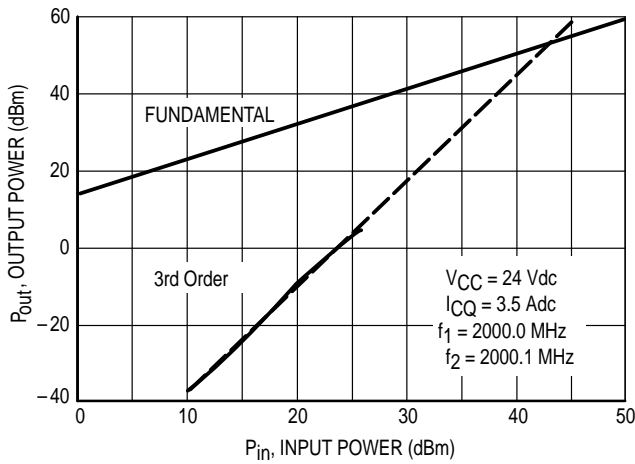
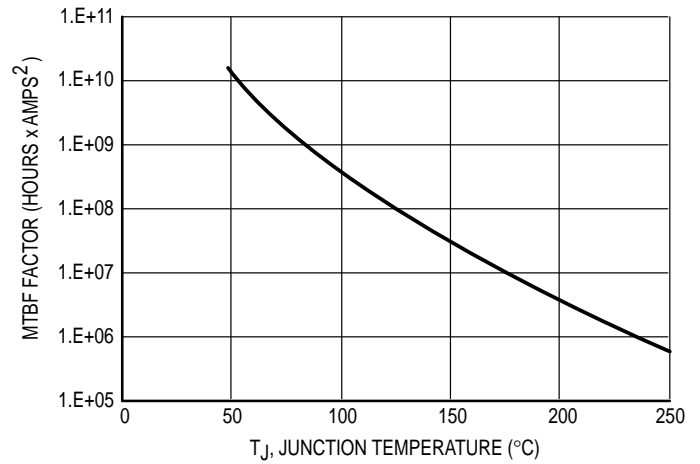
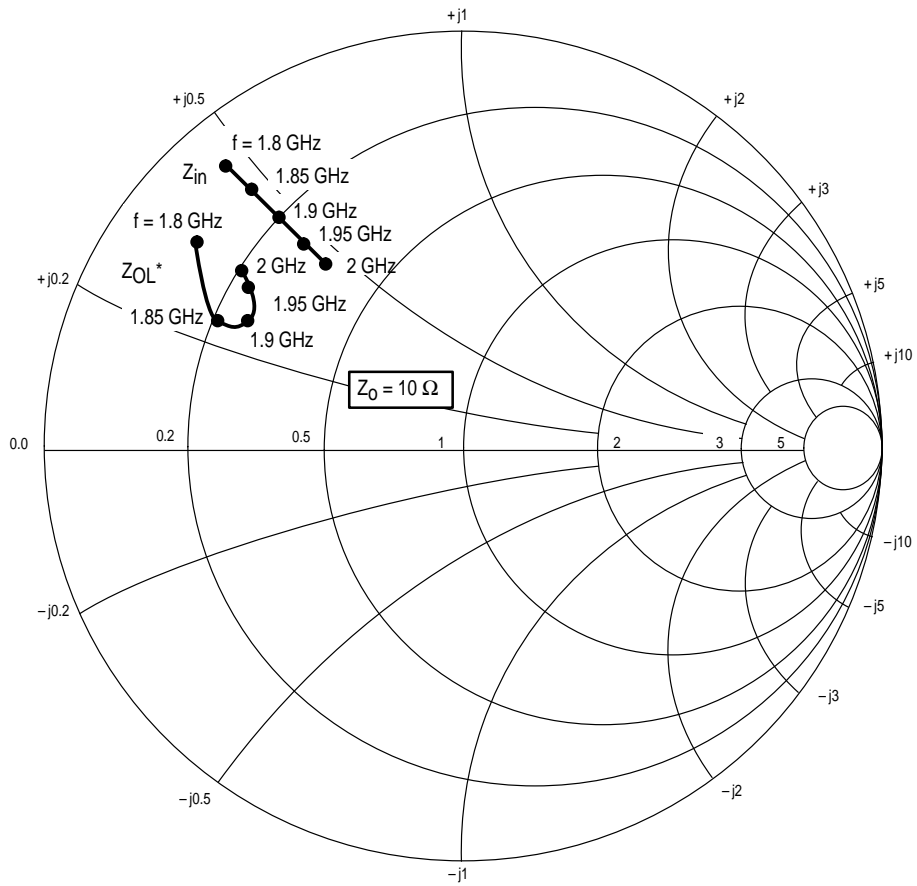

Figure 11. Class A Third Order Intercept Point



This above graph displays calculated MTBF in hours x ampere² emitter current. Life tests at elevated temperatures have correlated to better than ±10% of the theoretical prediction for metal failure. Divide MTBF factor by I_C^2 for MTBF in a particular application.

Figure 12. MTBF Factor versus Junction Temperature



$V_{CC} = 26 \text{ V}$, $I_{CQ} = 200 \text{ mA}$, $P_{out} = 60 \text{ W (PEP)}$

f MHz	$Z_{in}(1)$ Ω	Z_{OL}^* Ω
1800	$1.0 + j4.8$	$1.7 + j3.3$
1850	$1.5 + j4.8$	$2.2 + j2.7$
1900	$2.0 + j4.7$	$2.4 + j3.0$
1950	$2.5 + j4.7$	$2.3 + j3.2$
2000	$3.5 + j4.7$	$2.0 + j3.4$

$Z_{in}(1)$ = Conjugate of fixture base terminal impedance.

Z_{OL}^* = Conjugate of the optimum load impedance at given output power, voltage, bias current and frequency.

Figure 13. Series Equivalent Input and Output Impedance

Table 1. Common Emitter S-Parameters at $V_{CE} = 24$ Vdc, $I_C = 3.5$ Adc

f GHz	S11		S21		S12		S22	
	S11	$\angle \phi$	S21	$\angle \phi$	S12	$\angle \phi$	S22	$\angle \phi$
1.5	0.986	168	0.32	81	0.031	60	0.923	169
1.55	0.985	167	0.35	76	0.031	63	0.918	169
1.6	0.981	167	0.40	70	0.032	61	0.908	169
1.65	0.973	166	0.45	63	0.030	53	0.897	169
1.7	0.968	165	0.52	56	0.033	50	0.889	168
1.75	0.951	163	0.62	46	0.028	47	0.880	169
1.8	0.914	161	0.76	32	0.027	39	0.871	170
1.85	0.851	161	0.91	12	0.024	26	0.863	171
1.9	0.789	164	1.02	-15	0.015	5	0.888	174
1.95	0.810	170	0.94	-44	0.005	-7	0.931	174
2	0.880	172	0.75	-68	0.006	-151	0.953	172
2.05	0.934	170	0.57	-85	0.010	152	0.967	170
2.1	0.964	168	0.45	-98	0.015	158	0.965	169
2.15	0.977	165	0.36	-109	0.022	164	0.955	168
2.2	0.975	163	0.30	-118	0.033	165	0.950	167
2.25	0.961	161	0.25	-128	0.049	160	0.947	167
2.3	0.942	160	0.22	-139	0.066	149	0.938	166
2.35	0.919	157	0.19	-149	0.077	142	0.931	165
2.4	0.860	156	0.17	-163	0.100	137	0.922	165
2.45	0.821	159	0.15	177	0.128	122	0.914	165
2.5	0.781	161	0.14	157.0	0.156	108	0.907	165

PACKAGE DIMENSIONS

**CASE 451-04
ISSUE D**

NOTES:

- DIMENSIONING AND TOLERANCING PER ANSI Y14.5M, 1982.
- CONTROLLING DIMENSION: INCH.

DIM	INCHES		MILLIMETERS	
	MIN	MAX	MIN	MAX
A	0.995	1.005	25.27	25.53
B	0.380	0.390	9.65	9.91
C	0.170	0.205	4.32	5.21
D	0.455	0.465	11.56	11.81
E	0.060	0.075	1.52	1.91
F	0.004	0.006	0.10	0.15
G	0.800 BSC		20.32 BSC	
H	0.078	0.090	1.98	2.29
K	0.117	0.137	2.97	3.48
N	0.595	0.605	15.11	15.37
Q	0.120	0.130	3.05	3.30
R	0.395	0.410	10.03	10.41

STYLE 1:
PIN 1. COLLECTOR
2. BASE
3. EMITTER

**CASE 451A-01
ISSUE O**

NOTES:

- DIMENSIONING AND TOLERANCING PER ANSI Y14.5M, 1982.
- CONTROLLING DIMENSION: INCH.

DIM	INCHES		MILLIMETERS	
	MIN	MAX	MIN	MAX
A	0.615	0.625	15.62	15.88
B	0.395	0.410	10.03	10.41
C	0.170	0.205	4.32	5.21
D	0.455	0.465	11.56	11.81
E	0.060	0.075	1.52	1.91
F	0.004	0.006	0.10	0.15
H	0.078	0.090	1.98	2.29
K	0.117	0.137	2.97	3.48
N	0.595	0.605	15.11	15.37

STYLE 1:
PIN 1. COLLECTOR
2. BASE
3. EMITTER

Motorola reserves the right to make changes without further notice to any products herein. Motorola makes no warranty, representation or guarantee regarding the suitability of its products for any particular purpose, nor does Motorola assume any liability arising out of the application or use of any product or circuit, and specifically disclaims any and all liability, including without limitation consequential or incidental damages. "Typical" parameters which may be provided in Motorola data sheets and/or specifications can and do vary in different applications and actual performance may vary over time. All operating parameters, including "Typicals" must be validated for each customer application by customer's technical experts. Motorola does not convey any license under its patent rights nor the rights of others. Motorola products are not designed, intended, or authorized for use as components in systems intended for surgical implant into the body, or other applications intended to support or sustain life, or for any other application in which the failure of the Motorola product could create a situation where personal injury or death may occur. Should Buyer purchase or use Motorola products for any such unintended or unauthorized application, Buyer shall indemnify and hold Motorola and its officers, employees, subsidiaries, affiliates, and distributors harmless against all claims, costs, damages, and expenses, and reasonable attorney fees arising out of, directly or indirectly, any claim of personal injury or death associated with such unintended or unauthorized use, even if such claim alleges that Motorola was negligent regarding the design or manufacture of the part. Motorola and  are registered trademarks of Motorola, Inc. Motorola, Inc. is an Equal Opportunity/Affirmative Action Employer.

Mfax is a trademark of Motorola, Inc.

How to reach us:

USA/EUROPE/Locations Not Listed: Motorola Literature Distribution;
P.O. Box 5405, Denver, Colorado 80217. 303-675-2140 or 1-800-441-2447

JAPAN: Nippon Motorola Ltd.: SPD, Strategic Planning Office, 4-32-1,
Nishi-Gotanda, Shinagawa-ku, Tokyo 141, Japan. 81-3-5487-8488

Mfax™: RMFAX0@email.sps.mot.com – TOUCHTONE 602-244-6609
– US & Canada ONLY 1-800-774-1848

ASIA/PACIFIC: Motorola Semiconductors H.K. Ltd.; 8B Tai Ping Industrial Park,
51 Ting Kok Road, Tai Po, N.T., Hong Kong. 852-26629298

INTERNET: <http://motorola.com/sps>



MRF20060/D