

Designer's™ Data Sheet

SWITCHMODE™ Power Rectifier

... designed for use in switching power supplies, inverters and as free wheeling diodes, these state-of-the-art devices have the following features:

- Ultrafast 35 Nanosecond Recovery Times
- 175°C Operating Junction Temperature
- Popular TO-220 Package
- Epoxy Meets UL94, V_O @ 1/8"
- High Temperature Glass Passivated Junction
- High Voltage Capability to 600 Volts
- Low Leakage Specified @ 150°C Case Temperature
- Current Derating @ Both Case and Ambient Temperatures

Mechanical Characteristics

- Case: Epoxy, Molded
- Weight: 1.9 grams (approximately)
- Finish: All External Surfaces Corrosion Resistant and Terminal Leads are Readily Solderable
- Lead Temperature for Soldering Purposes: 260°C Max. for 10 Seconds
- Shipped 50 units per plastic tube
- Marking: UH860

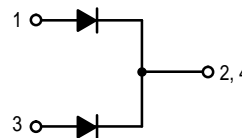

MURH860CT

Motorola Preferred Device

ULTRAFAST RECTIFIER
8.0 AMPERES
600 VOLTS

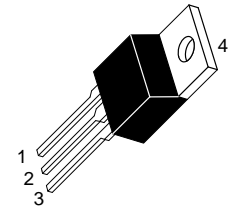

CASE 221A-06
TO-220AB

MAXIMUM RATINGS, PER LEG

Rating	Symbol	Value	Unit
Peak Repetitive Reverse Voltage Working Peak Reverse Voltage DC Blocking Voltage	V _{RRM} V _{RWM} V _R	600	Volts
Average Rectified Forward Current Total Device, (Rated V _R), T _C = 120°C	I _{F(AV)}	4.0 8.0	Amps
Peak Repetitive Forward Current (Rated V _R , Square Wave, 20 kHz), T _C = 120°C	I _{FM}	16	Amps
Nonrepetitive Peak Surge Current (Surge applied at rated load conditions halfwave, single phase, 60 Hz)	I _{FSM}	100	Amps
Operating Junction Temperature and Storage Temperature	T _J , T _{stg}	-65 to +175	°C

THERMAL CHARACTERISTICS, PER LEG

Maximum Thermal Resistance, Junction to Case	R _{θJC}	3.0	°C/W
--	------------------	-----	------

ELECTRICAL CHARACTERISTICS, PER LEG

Maximum Instantaneous Forward Voltage (1) (i _F = 4.0 Amps, T _C = 150°C) (i _F = 4.0 Amps, T _C = 25°C)	v _F	2.5 2.8	Volts
Maximum Instantaneous Reverse Current (1) (Rated dc Voltage, T _C = 150°C) (Rated dc Voltage, T _C = 25°C)	i _R	500 10	μA
Maximum Reverse Recovery Time (I _F = 1.0 Amp, di/dt = 50 Amps/μs)	t _{rr}	35	ns

(1) Pulse Test: Pulse Width = 300 μs, Duty Cycle ≤ 2.0%

Designer's Data for "Worst Case" Conditions — The Designer's Data Sheet permits the design of most circuits entirely from the information presented. SOA Limit curves — representing boundaries on device characteristics — are given to facilitate "worst case" design.

Designer's and SWITCHMODE are trademarks of Motorola, Inc.

Preferred devices are Motorola recommended choices for future use and best overall value.

MURH860CT

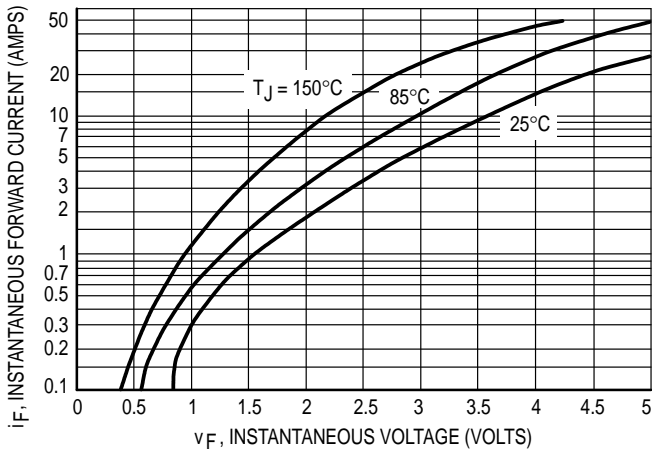

Figure 1. Typical Forward Voltage, Per Leg

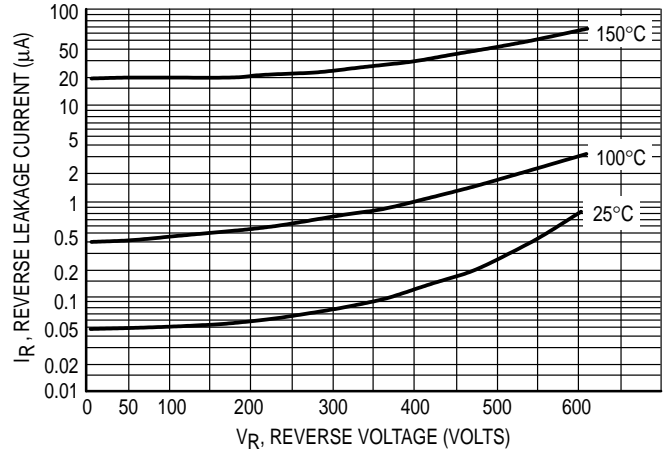

Figure 2. Typical Reverse Leakage Current, Per Leg

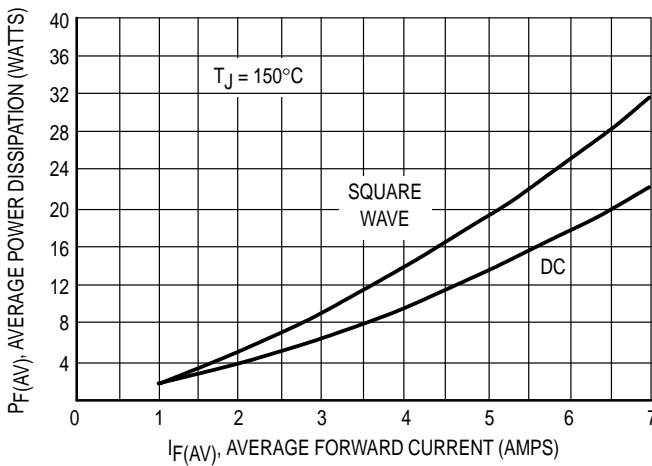

Figure 3. Typical Forward Dissipation, Per Leg

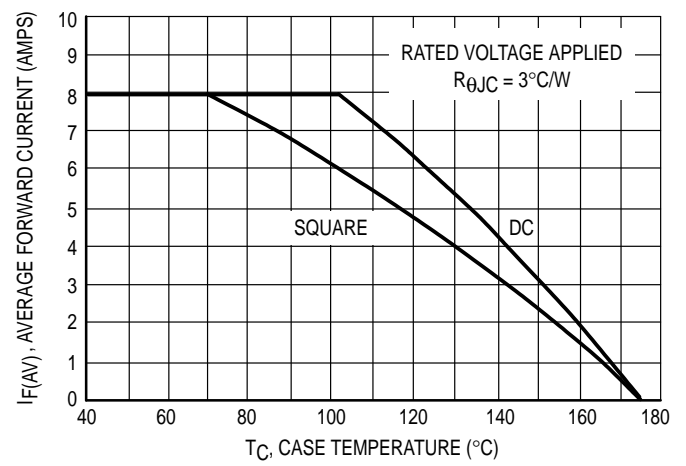

Figure 4. Typical Current Derating, Case, Per Leg

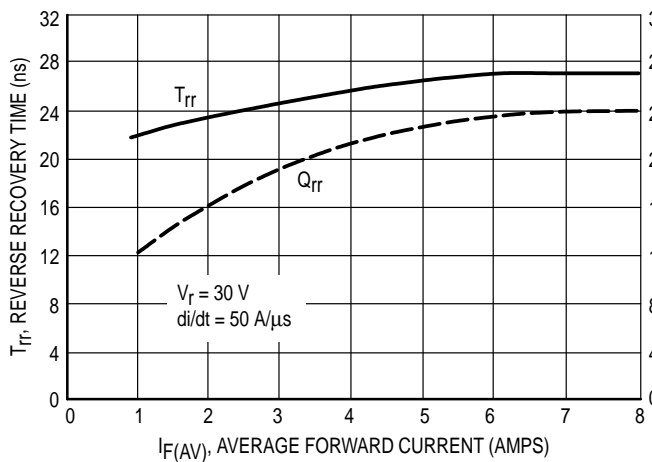

Figure 5. Typical Recovery Characteristics

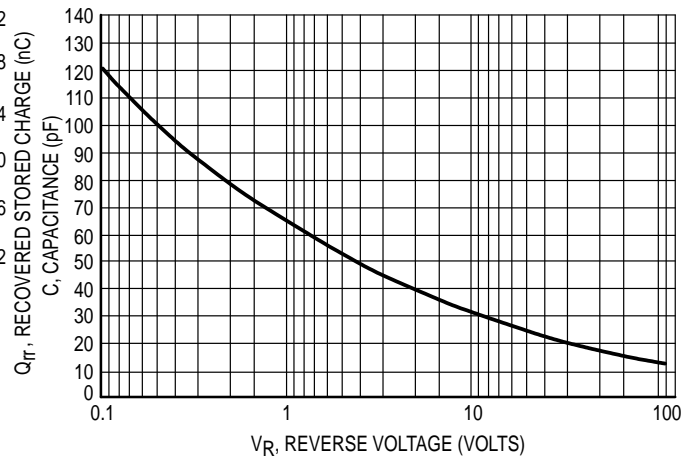
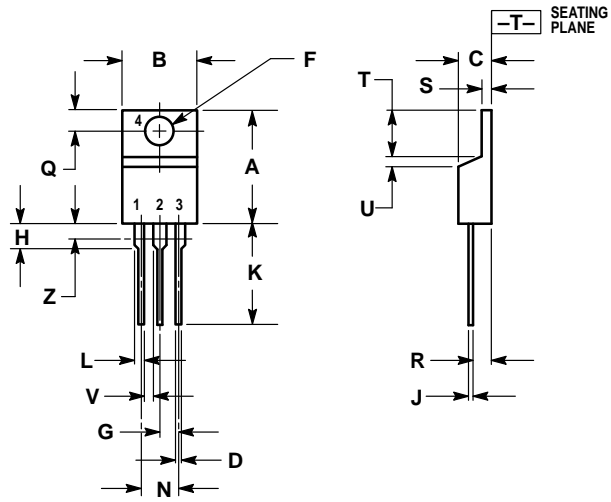

Figure 6. Typical Capacitance, Per Leg

PACKAGE DIMENSIONS



- NOTES:
1. DIMENSIONING AND TOLERANCING PER ANSI Y14.5M, 1982.
 2. CONTROLLING DIMENSION: INCH.
 3. DIMENSION Z DEFINES A ZONE WHERE ALL BODY AND LEAD IRREGULARITIES ARE ALLOWED.

DIM	INCHES		MILLIMETERS	
	MIN	MAX	MIN	MAX
A	0.570	0.620	14.48	15.75
B	0.380	0.405	9.66	10.28
C	0.160	0.190	4.07	4.82
D	0.025	0.035	0.64	0.88
F	0.142	0.147	3.61	3.73
G	0.095	0.105	2.42	2.66
H	0.110	0.155	2.80	3.93
J	0.018	0.025	0.46	0.64
K	0.500	0.562	12.70	14.27
L	0.045	0.060	1.15	1.52
N	0.190	0.210	4.83	5.33
Q	0.100	0.120	2.54	3.04
R	0.080	0.110	2.04	2.79
S	0.045	0.055	1.15	1.39
T	0.235	0.255	5.97	6.47
U	0.000	0.050	0.00	1.27
V	0.045	—	1.15	—
Z	—	0.080	—	2.04

CASE 221A-06
(TO-220AB)
ISSUE Y

Motorola reserves the right to make changes without further notice to any products herein. Motorola makes no warranty, representation or guarantee regarding the suitability of its products for any particular purpose, nor does Motorola assume any liability arising out of the application or use of any product or circuit, and specifically disclaims any and all liability, including without limitation consequential or incidental damages. "Typical" parameters which may be provided in Motorola data sheets and/or specifications can and do vary in different applications and actual performance may vary over time. All operating parameters, including "Typicals" must be validated for each customer application by customer's technical experts. Motorola does not convey any license under its patent rights nor the rights of others. Motorola products are not designed, intended, or authorized for use as components in systems intended for surgical implant into the body, or other applications intended to support or sustain life, or for any other application in which the failure of the Motorola product could create a situation where personal injury or death may occur. Should Buyer purchase or use Motorola products for any such unintended or unauthorized application, Buyer shall indemnify and hold Motorola and its officers, employees, subsidiaries, affiliates, and distributors harmless against all claims, costs, damages, and expenses, and reasonable attorney fees arising out of, directly or indirectly, any claim of personal injury or death associated with such unintended or unauthorized use, even if such claim alleges that Motorola was negligent regarding the design or manufacture of the part. Motorola and  are registered trademarks of Motorola, Inc. Motorola, Inc. is an Equal Opportunity/Affirmative Action Employer.

Mfax is a trademark of Motorola, Inc.

How to reach us:

USA/EUROPE/Locations Not Listed: Motorola Literature Distribution;
P.O. Box 5405, Denver, Colorado 80217. 303-675-2140 or 1-800-441-2447

JAPAN: Nippon Motorola Ltd.; Tatsumi-SPD-JLDC, 6F Seibu-Butsuryu-Center,
3-14-2 Tatsumi Koto-Ku, Tokyo 135, Japan. 81-3-3521-8315

Mfax™: RMFAX0@email.sps.mot.com – TOUCHTONE 602-244-6609
– US & Canada ONLY 1-800-774-1848

ASIA/PACIFIC: Motorola Semiconductors H.K. Ltd.; 8B Tai Ping Industrial Park,
51 Ting Kok Road, Tai Po, N.T., Hong Kong. 852-26629298

INTERNET: <http://motorola.com/sps>

