

W91440N SERIES



10-MEMORY TONE/PULSE DIALER WITH SAVE FUNCTION

GENERAL DESCRIPTION

The W91440N series are Si-gate CMOS ICs that provide the necessary signals for either tone or pulse dialing. The W91440N series features save memory and a 10 by 16 digit automatic dialing memory.

FEATURES

- DTMF/pulse switchable dialer
- Two by 32 digit redial and save memory
- Ten by 16 digit two-touch direct memory
- Redial memory cascadable with normal dialing; dialing length is unlimited, but if length oversteps 32 digits the redial function is inhibited
- Pulse-to-tone (*T) keypad for long distance call operation
- Uses 5 × 5 keyboard
- Easy operation with redial, flash, pause and *T keypads
- Flash, pause, P→T (Pulse-to-tone) can be stored as a digit in memory
- Dialing rate (10, 20 ppS) selected by bonding option
- On-hook debounce time: 150 msec.
- Minimum tone output duration: 93 msec.
- Minimum intertone pause: 93 msec.
- Flash break time (73, 100, 300, 600 msec.) selectable by keypad, and the pause time is 1 sec.
- On-chip power-on reset
- Uses 3.579545 MHz crystal or ceramic resonator
- Packaged in 18-pin plastic DIP
- The different dialers in the W91440N series are shown in the following table:

TYPE NO.	REPLACEMENT TYPE NO.	PULSE (ppS)	FLASH (mS)	PAUSE (S)	M/B
W91442N	W91442	10	600/300/73/100	3.6	Pin
	W91443				
	W91444				
	W91446				
	W91447				
	W91444G				
	W91445G				
W91443N	W91443	20	600/300/73/100	3.6	Pin

PIN CONFIGURATION

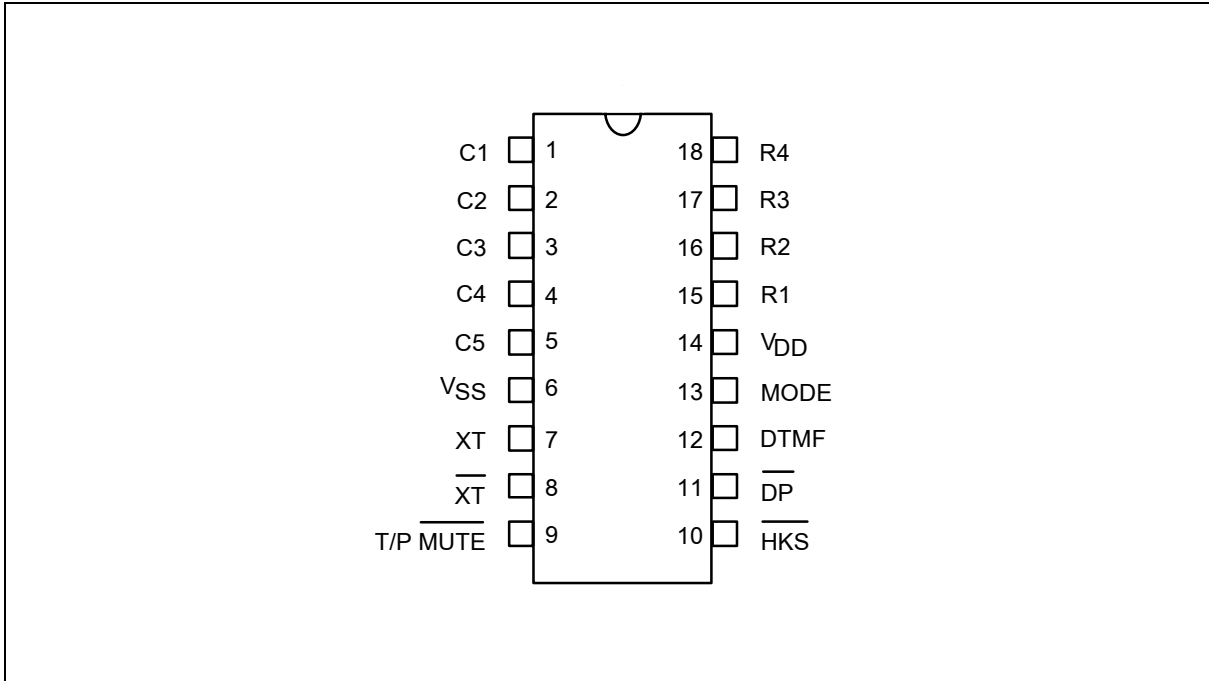

PIN DESCRIPTION

SYMBOL	PIN	I/O	FUNCTION
Column-Row Inputs	1-5 & 15-18	I	The keyboard inputs may be used with either a standard 5 × 5 keyboard or an inexpensive single contact (Form A) keyboard. Electronic input from a μ C can also be used. A valid key in is defined as a single row being connected to a single column.
XT, XT-bar	7, 8	I, O	A built-in inverter provides oscillation with an inexpensive 3.579545 MHz crystal or ceramic resonator.
T/P MUTE-bar	9	O	The T/P MUTE is a conventional CMOS N-channel open drain output. The output transistor is switched on during dialing sequence and flash break time. Otherwise, it is switched off.
MODE	13	I	Pulling mode pin to VSS places the dialer in tone mode. Pulling mode pin to VDD places the dialer in pulse mode with M/B ratio 40:60 (10 ppS only for W91442N and 20 ppS for W91443N). Floating mode pin places the dialer in pulse mode with M/B ratio 33:67 (10 ppS only for W91442N and 20 ppS for W91443N).

W91440N SERIES



Pin Description, continued

SYMBOL	PIN	I/O	FUNCTION																																				
$\overline{\text{HKS}}$	10	I	<p>Hook switch input.</p> <p>$\overline{\text{HKS}} = \text{VDD}$: On-hook state. Chip in sleeping mode, no operation.</p> <p>$\overline{\text{HKS}} = \text{Vss}$: Off-hook state. Chip is enabled for normal operation.</p> <p>$\overline{\text{HKS}}$ pin is pulled to VDD by internal resistor.</p>																																				
$\overline{\text{DP}}$	11	O	<p>N-channel open drain dialing pulse output.</p> <p>Flash key will cause $\overline{\text{DP}}$ to be active in either tone mode or pulse mode.</p> <p>The timing diagram in pulse mode is shown in Figure 1(a, b, c).</p>																																				
VDD, VSS	14, 6	I	Power input pins.																																				
DTMF	12	O	<p>In pulse mode, this pin remains in low state at all time.</p> <p>In the tone mode, it will output a dual or single tone.</p> <p>Detailed timing diagram for tone mode is shown in Figure 2(a, b, c).</p> <table border="1" style="margin-left: auto; margin-right: auto;"> <thead> <tr> <th colspan="4">Output Frequency</th> </tr> <tr> <th></th> <th>Specified</th> <th>Actual</th> <th>Error %</th> </tr> </thead> <tbody> <tr> <td>R1</td> <td>697</td> <td>699</td> <td>+0.28</td> </tr> <tr> <td>R2</td> <td>770</td> <td>766</td> <td>-0.52</td> </tr> <tr> <td>R3</td> <td>852</td> <td>848</td> <td>-0.47</td> </tr> <tr> <td>R4</td> <td>941</td> <td>948</td> <td>+0.74</td> </tr> <tr> <td>C1</td> <td>1209</td> <td>1216</td> <td>+0.57</td> </tr> <tr> <td>C2</td> <td>1336</td> <td>1332</td> <td>-0.30</td> </tr> <tr> <td>C3</td> <td>1477</td> <td>1472</td> <td>-0.34</td> </tr> </tbody> </table>	Output Frequency					Specified	Actual	Error %	R1	697	699	+0.28	R2	770	766	-0.52	R3	852	848	-0.47	R4	941	948	+0.74	C1	1209	1216	+0.57	C2	1336	1332	-0.30	C3	1477	1472	-0.34
Output Frequency																																							
	Specified	Actual	Error %																																				
R1	697	699	+0.28																																				
R2	770	766	-0.52																																				
R3	852	848	-0.47																																				
R4	941	948	+0.74																																				
C1	1209	1216	+0.57																																				
C2	1336	1332	-0.30																																				
C3	1477	1472	-0.34																																				



BLOCK DIAGRAM

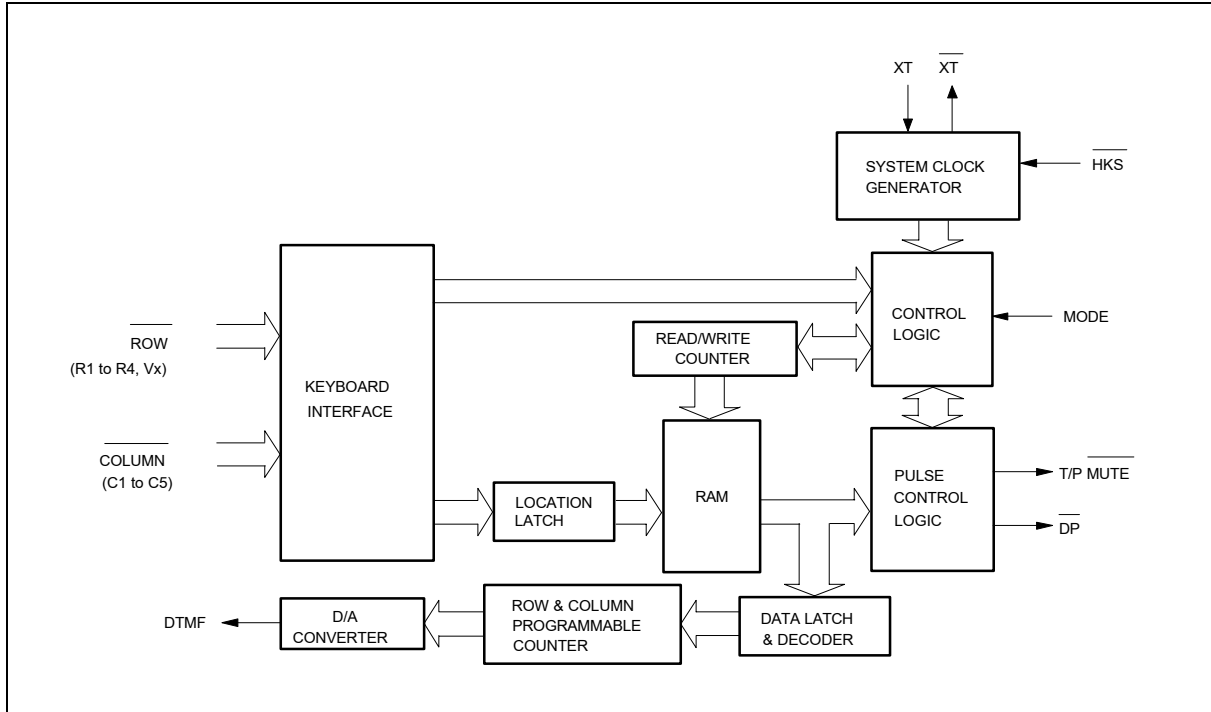

FUNCTIONAL DESCRIPTION

Keyboard Operation

C1	C2	C3	C4	C5	
1	2	3	S		R1
4	5	6	F4		R2
7	8	9	A		R3
*/T	0	#	R/P	SAVE	R4
F1	F2	F3			VX

- S: Store function key
- A: Indirect repertory dialing function key
- R/P: Redial and pause function key
- SAVE: Save function key
- */T: * in tone mode and P→T in pulse mode
- F1, ..., F4: Flash keys, F1 = 600 mS, F2 = 300 mS, F3 = 73 mS, F4 = 100 mS

Note: D1, ..., Dn, D1', ..., Dn': 0, ..., 9, */T, #; Ln: 0, ..., 9; Fn: F1, ..., F4



Normal Dialing

OFF HOOK , D1 , D2 , ..., Dn

1. D1, D2, ..., Dn will be dialed out.
2. Dialing length is unlimited, but redial is inhibited if length oversteps 32 digits in normal dialing.

Redialing

OFF HOOK , D1 , D2 , ..., Dn Busy, Come ON HOOK , OFF HOOK , R/P

1. The redial memory content will be dialed out.
2. The R/P key can execute the redial function only as the first key-in after off-hook; otherwise, it executes pause function.
3. If redialing length oversteps 32 digits, the redialing function will be inhibited.

Number Store

OFF HOOK , D1 , D2 , ..., Dn , S , S , Ln

1. If the sequence of the dialed digits D1, D2, ..., Dn has not finished, S will be ignored.
2. D1, D2, ..., Dn will be stored in memory location and dialed out.
OFF HOOK , S , D1 , D2 , ..., Dn , S , Ln
3. D1, D2, ..., Dn will be stored in memory location but will not be dialed out.
4. R/P and */T keys can be stored as a digit in memory.

In store mode, R/P is the pause function key; */T is the pulse to tone function key.

5. The store mode is released after the store function is executed or when the state of the hook switch is changed.

Repertory Dialing

OFF HOOK , A , Ln

Access Pause

OFF HOOK , D1 , D2 , R/P , D3 , ..., Dn

1. The pause function can be stored as a digit in memory.
2. The pause function is executed in normal dialing, redial dialing, or memory dialing.
3. A detailed timing diagram for the pause function is shown in Figure 3.



Pulse-to-tone (*T)

OFF HOOK , D1 , D2 , ..., Dn , *T , D1' , D2' , ..., Dn'

1. If the mode switch is set in pulse mode, then the output signal will be:

D1, D2, ..., Dn, Pause (3.6 sec.), D1', D2', ..., Dn'
(Pulse) (Tone)

2. If the mode switch is set in tone mode, then the output signal will be the form as follow:

D1, D2, ..., Dn, *, D1', D2', ..., Dn'
(Tone) (Tone)

3. The dialer remains in tone mode when the digits have been dialed out and can be reset to pulse mode by going on-hook.

4. The pulse-to-tone function timing diagram is shown in Figure 4.

Flash

OFF HOOK , Fn

1. Fn = F1, ..., F4

2. The dialer will execute flash break time of 600 mS (F1), 300 mS (F2), 73 mS (F3), or 100 mS (F4) and all the flash pause time is 1.0 sec. before the next digit is dialed out.

3. Flash key can be stored as a digit in memory; however, only one flash will be released to users.

4. The system will return to the initial state after the flash pause time is finished.

5. The timing diagram of flash function is shown in Figure 5.

Save

OFF HOOK , D1 , D2 , ..., Dn , SAVE

1. If the dialing of D1 to Dn is finished, pressing the SAVE key will cause D1 to Dn to be copied to the save memory.

OFF HOOK , SAVE

2. D1 to Dn will be dialed out after the save key is pressed.

Cascaded Dialing

1. Normal Dialing + Repertory Dialing + Normal Dialing

2. Repertory Dialing + Normal Dialing + Repertory Dialing

3. Redialing + Normal Dialing + Repertory Dialing

4. Redialing is valid as first key-in only.

W91440N SERIES



ABSOLUTE MAXIMUM RATINGS

PARAMETER	SYMBOL	RATING	UNIT
DC Supply Voltage	VDD-VSS	-0.3 to +7.0	V
Input/Output Voltage	VIL	VSS -0.3	V
	VIH	VDD +0.3	V
	VOL	VSS -0.3	V
	VOH	VDD +0.3	V
Power Dissipation	PD	120	mW
Operation Temperature	TOPR	-20 to +70	°C
Storage Temperature	TSTG	-55 to +150	°C

Note: Exposure to conditions beyond those listed under Absolute Maximum Ratings may adversely affect the life and reliability of the device.

DC CHARACTERISTICS

(VDD-VSS = 2.5V, Fosc. = 3.579545 MHz, TA = 25° C, all outputs unloaded)

PARAMETER	SYMBOL	CONDITIONS	MIN.	TYP.	MAX.	UNIT
Operating Voltage	VDD	-	2.0	-	5.5	V
Operating Current	IOP	Tone, Unloaded	-	0.4	0.60	mA
		Pulse, Unloaded	-	0.2	0.40	
Standby Current	ISB	HKS = VSS, No load & No key entry	-	-	15	μA
Memory Retention Current	IMR	HKS = VDD, VDD = 1.0V	-	-	0.2	μA
DTMF Output Voltage	VTO	Row group, RL = 5 KΩ	130	150	170	mVrms
Pre-emphasis		Col/Row, VDD = 2.0 to 5.5V	1	2	3	dB
DTMF Distortion	THD	RL = 5 KΩ, VDD = 2.0 to 5.5V	-	-30	-23	dB
DTMF Output DC Level	VTDC	RL = 5 KΩ, VDD = 2.0 to 5.5V	1.0	-	3.0	V
DTMF Output Sink Current	ITL	VTO = 0.5V	0.2	-	-	mA

W91440N SERIES



DC Characteristics, continued

PARAMETER	SYMBOL	CONDITIONS	MIN.	TYP.	MAX.	UNIT
\overline{DP} Output Sink Current	IPL	VPO = 0.5V	0.5	-	-	mA
T/P \overline{MUTE} Output Sink Current	ITML	VTMO = 0.5V	0.5	-	-	mA
Keypad Input Drive Current	IKD	VI = 0.0V	30	-	-	μ A
Keypad Input Sink Current	IKS	VI = 2.5V	200	400	-	μ A
\overline{HKS} I/P Pull-High Resistor	RHK	-	-	300	-	K Ω
Keypad Resistance	RK	-	-	-	5.0	K Ω

AC CHARACTERISTICS

(VDD-VSS = 2.5V, Fosc. = 3.579545 MHz, TA = 25° C, all outputs unloaded)

PARAMETER	SYMBOL	CONDITIONS	MIN.	TYP.	MAX.	UNIT
Key in Debounce	TKID	-	-	20	-	mS
Key Release Debounce	TKRD	-	-	20	-	mS
Pulse Mute Delay	TMD	Mode = VDD	-	40	-	mS
		Mode = Floating	-	33.3	-	
Pre-digit-pause1	TPDP1 10 ppS	Mode = VDD	-	40	-	mS
		Mode = Floating	-	33.3	-	
Pre-digit-pause2	TPDP2 20 ppS	Mode = VDD	-	20	-	mS
		Mode = Floating	-	16.7	-	
Interdigit Pause (Auto Dialing)	TIDP	10 ppS	-	800	-	mS
		20 ppS	-	500	-	
Make/Break Ratio	M:B	Mode = VDD	-	40:60	-	%
		Mode = Floating	-	33:67	-	
Tone Output Duration	TTD	Auto dialing	-	93	-	mS
Intertone Pause	TITP	Auto dialing	-	93	-	mS
Flash Break Time	TFB	F1	-	600	-	mS
		F2	-	300	-	
		F3	-	73	-	
		F4	-	100	-	

W91440N SERIES



AC Characteristics, continued

PARAMETER	SYMBOL	CONDITIONS	MIN.	TYP.	MAX.	UNIT
Flash Pause Time	TFP	F1, F2, F3, F4	-	1.0	-	S
Pause Time	TP		-	3.6	-	S
On-hook Debounce Time	TOHD		-	150	-	S

Notes:

- Crystal parameters suggested for proper operation are $R_s < 100$ ohms, $L_m = 96$ mH, $C_m = 0.02$ pF, $C_n = 5$ pF, $C_i = 18$ pF, $F_{osc.} = 3.579545$ MHz $\pm 0.02\%$.
- Crystal oscillator accuracy directly affects these times.

TIMING WAVEFORMS

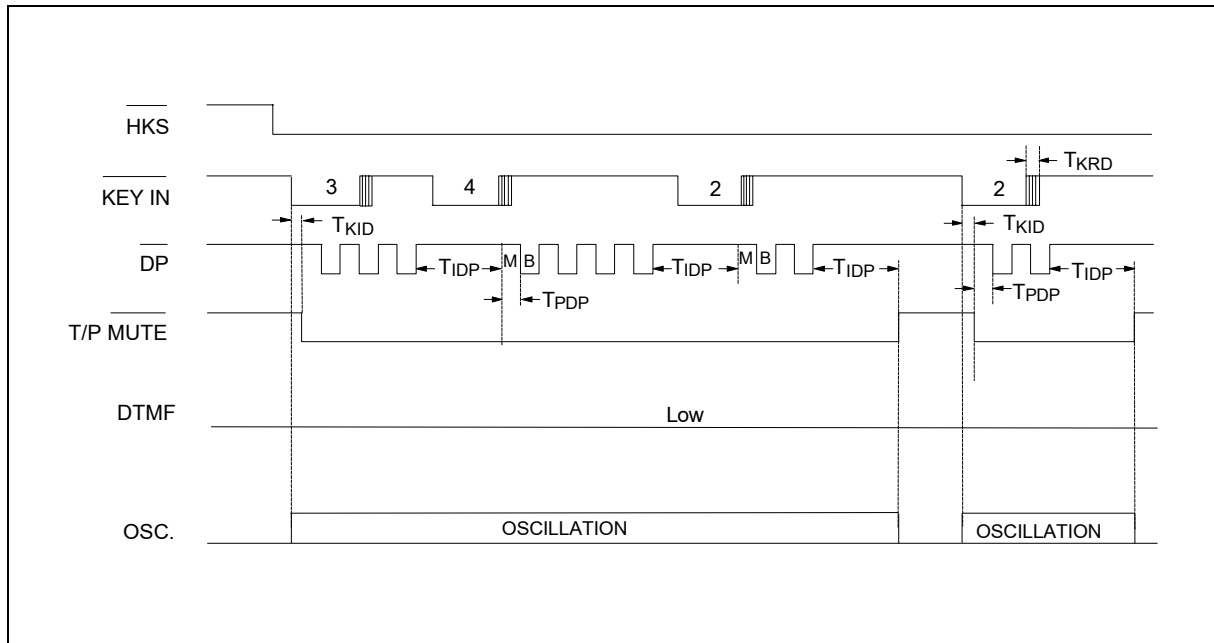

Figure 1(a) Normal Dialing Timing Diagram

W91440N SERIES



Timing Waveforms, continued

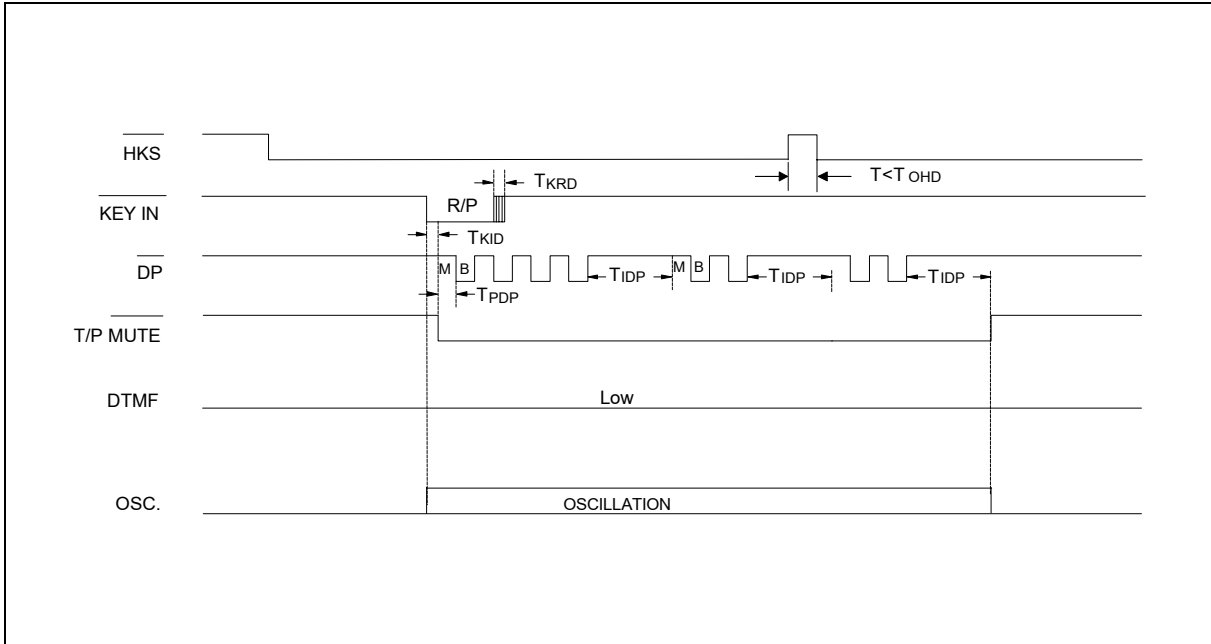

Figure 1(b) Pulse Mode Auto Dialing Timing Diagram

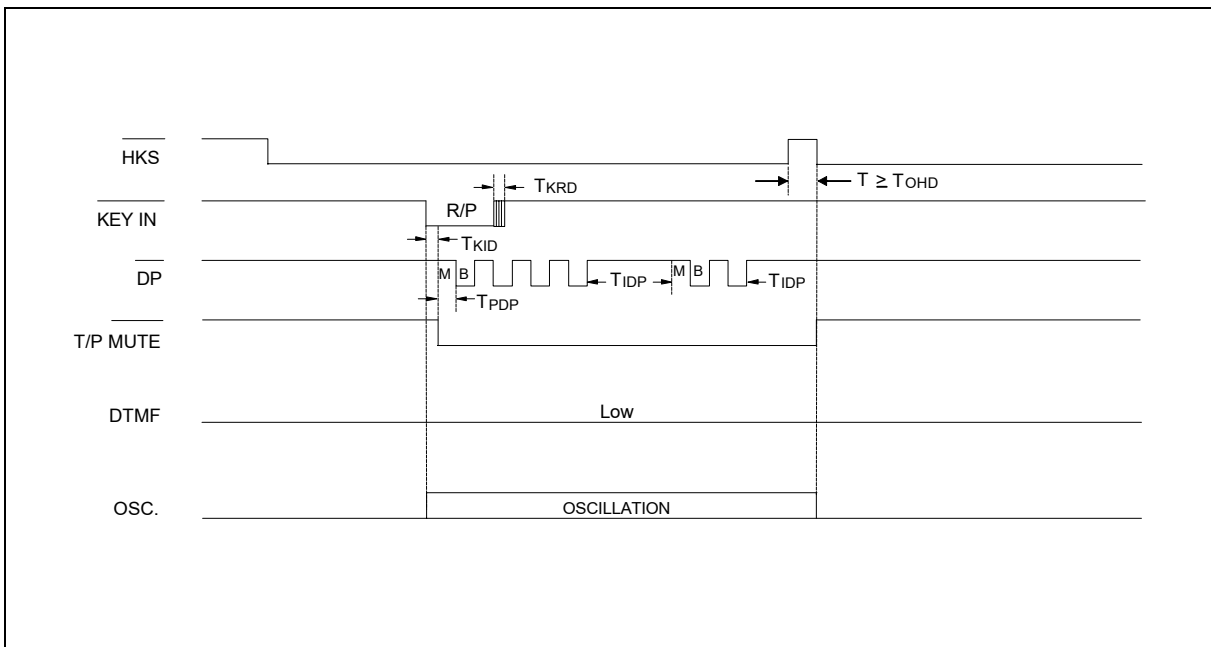

Figure 1(c) Pulse Mode Auto Dialing Timing Diagram

W91440N SERIES



Timing Waveforms, continued

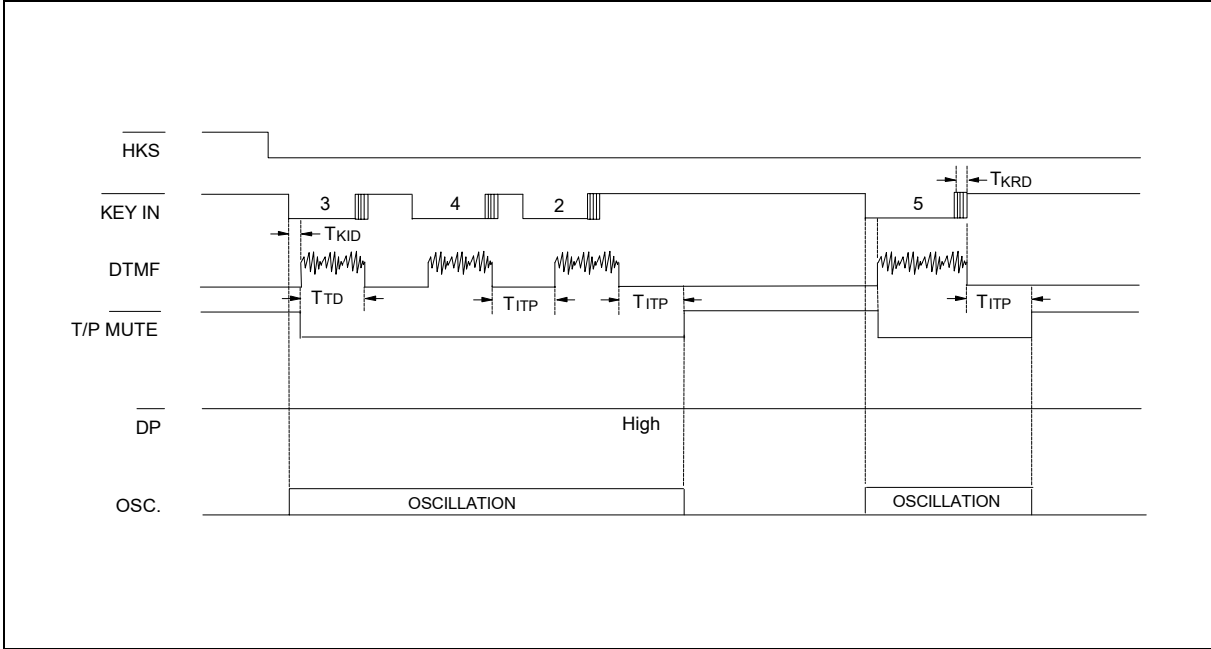

Figure 2(a) Tone Mode Normal Dialing Timing Diagram

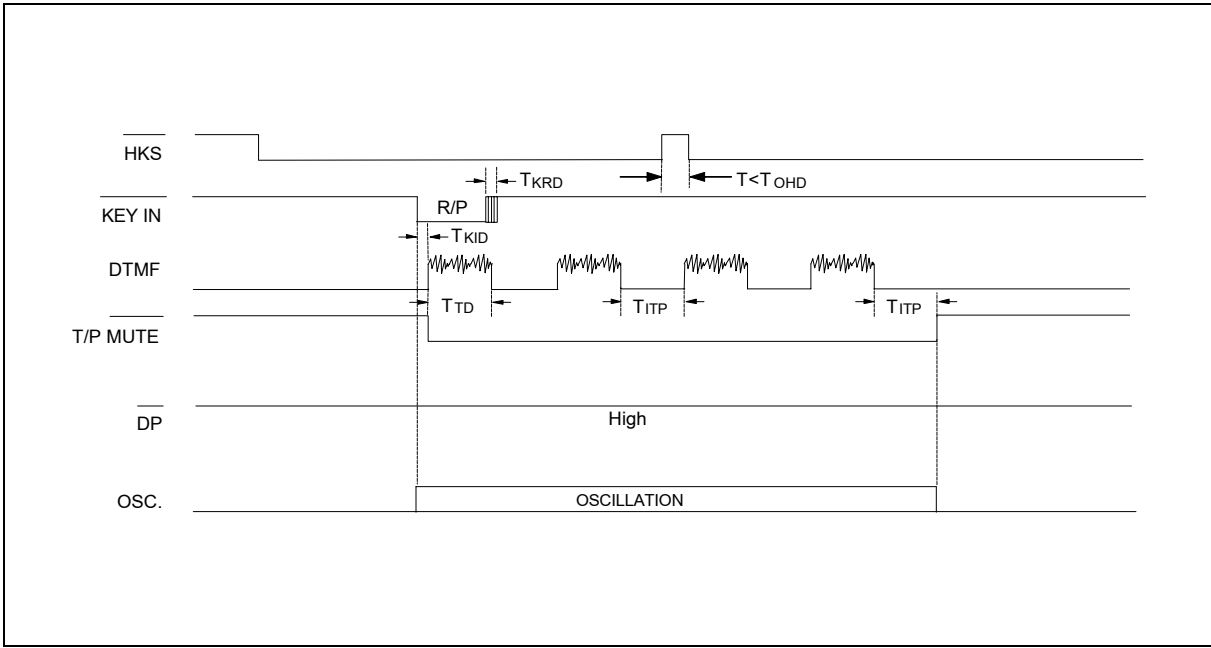

Figure 2(b) Tone Mode Auto Dialing Timing Diagram

W91440N SERIES



Timing Waveforms, continued

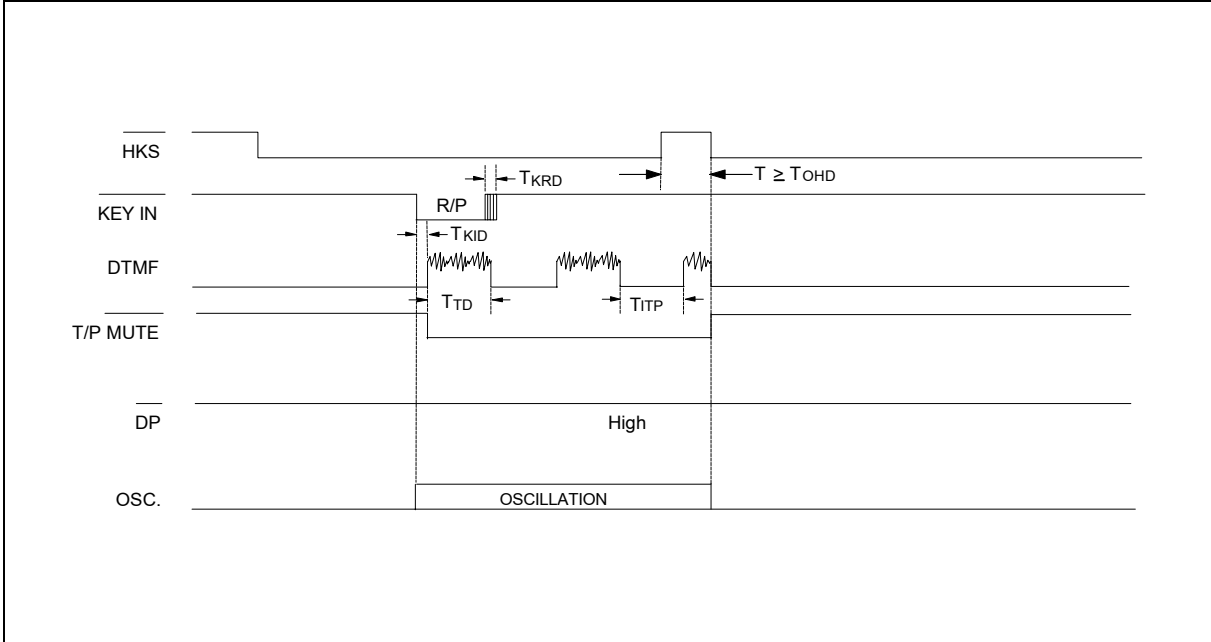

Figure 2(c) Tone Mode Auto Dialing Timing Diagram

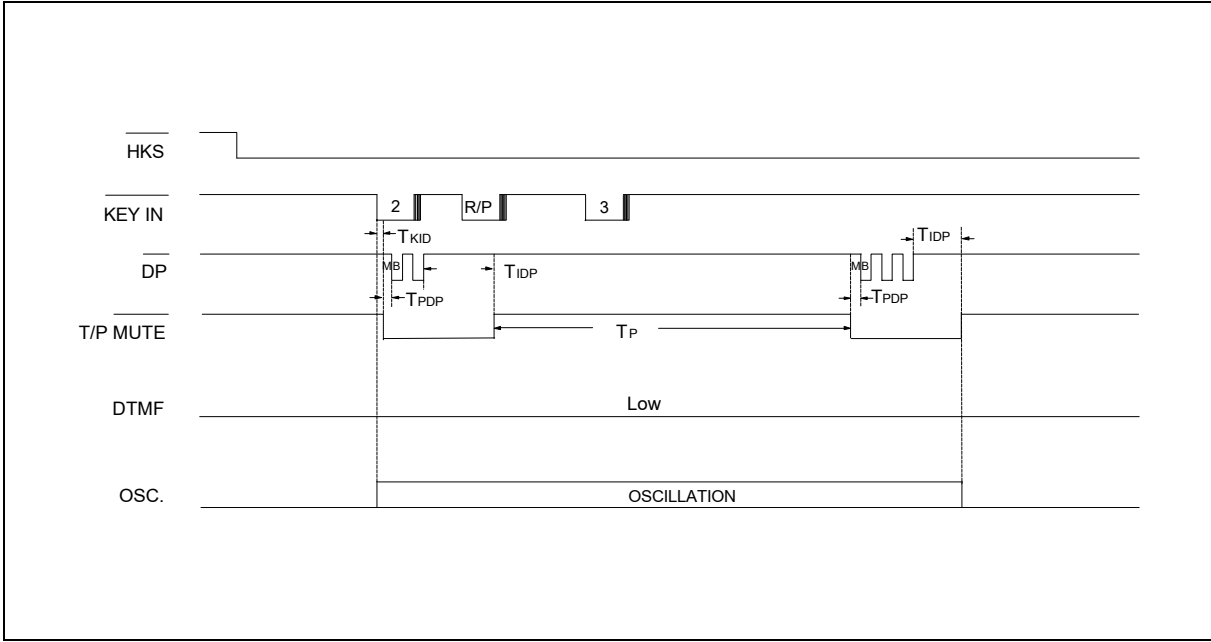

Figure 3. Pause Function Timing Diagram



Timing Waveforms, continued

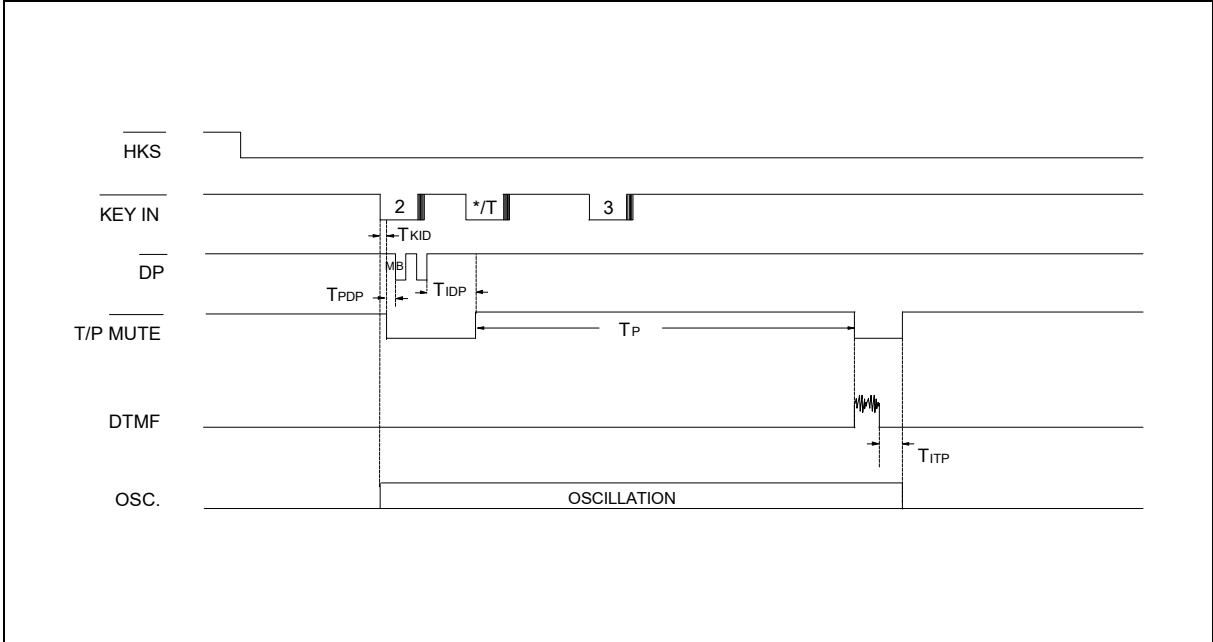

Figure 4. Pulse-to-tone Timing Diagram

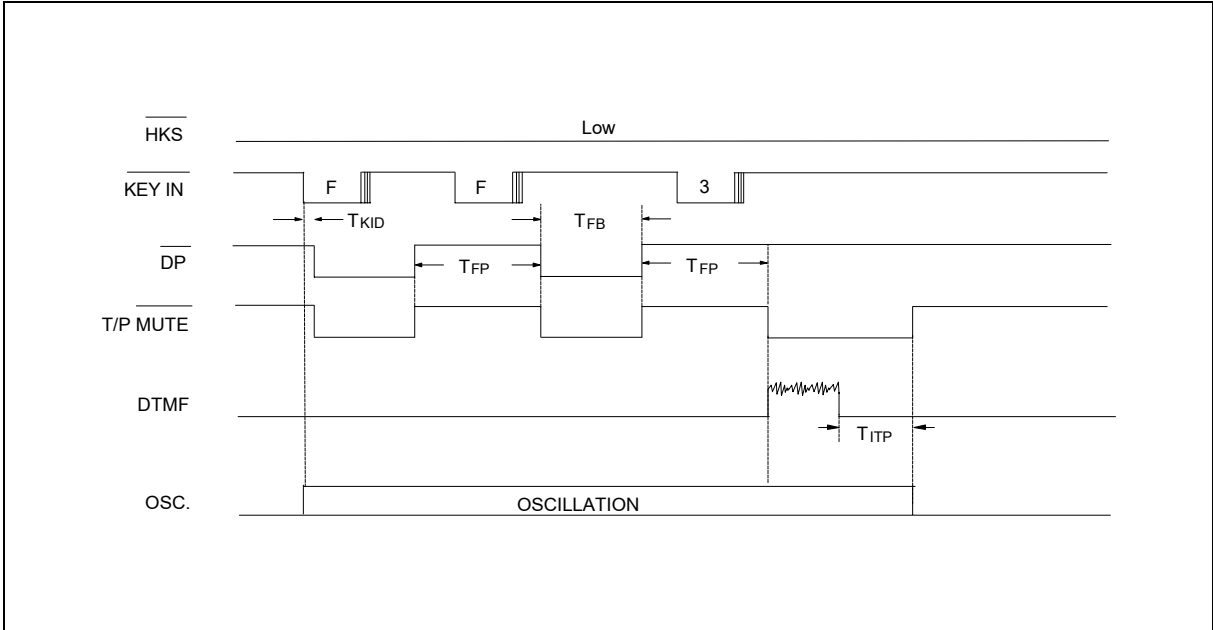

Figure 5. Flash Timing Diagram

W91440N SERIES



Headquarters

No. 4, Creation Rd. III,
Science-Based Industrial Park,
Hsinchu, Taiwan
TEL: 886-3-5770066
FAX: 886-3-5792697
<http://www.winbond.com.tw/>
Voice & Fax-on-demand: 886-2-7197006

Taipei Office

11F, No. 115, Sec. 3, Min-Sheng East Rd.,
Taipei, Taiwan
TEL: 886-2-7190505
FAX: 886-2-7197502

Winbond Electronics (H.K.) Ltd.

Rm. 803, World Trade Square, Tower II,
123 Hoi Bun Rd., Kwun Tong,
Kowloon, Hong Kong
TEL: 852-27513100
FAX: 852-27552064

Winbond Electronics North America Corp.

Winbond Memory Lab.
Winbond Microelectronics Corp.
Winbond Systems Lab.
2730 Orchard Parkway, San Jose,
CA 95134, U.S.A.
TEL: 1-408-9436666
FAX: 1-408-9436668

Note: All data and specifications are subject to change without notice.